

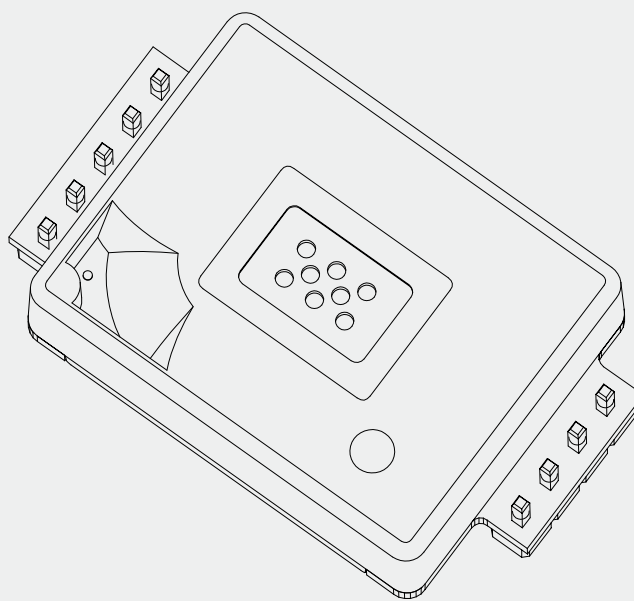

MEMSF MTP40-F



S P E C I F I C A T I O N

MTP40-F NDIR CO₂ Sensor Module

◆ Appearances and Dimensions

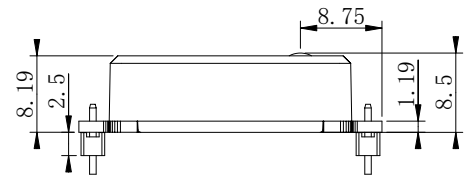
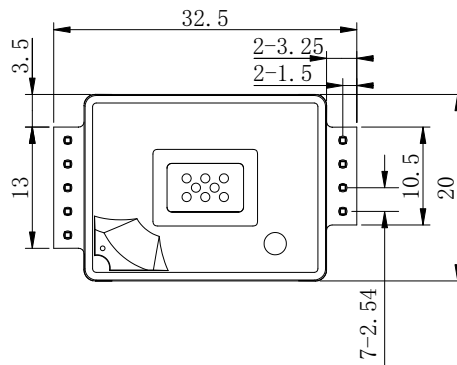
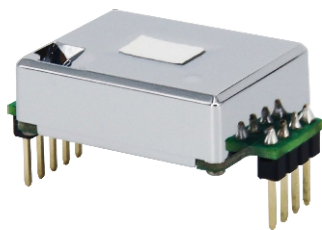

◆ Specifications

MEMSF MTP40-F CO ₂ Module	
Target Gas	CO ₂
Operating Principle	NDIR
Measurement Range	0ppm---2000ppm
Measurement Interval	2s
Accuracy	±(50ppm ± 5% of reading)
Response Time	T90 time is 90s
Operating Temperature	0-50°C
Operating Humidity	0-90% RH non condensed
Storage Temperature	-20°C---60°C
Dimensions	32.5×20×8.5mm(max dimensions)
Power Supply	4.2V---5.5V
Power Consumption	300mA peak, 4mA normal, 13mA average
Life Expectancy	10 years+
Serial Communication	Uart /IIC
PWM Output	Period: 1004ms, Pulse: 2ms-1002ms(0---2000ppm)
Alarm Output	>1000ppm output to 1, <800ppm output to 0, open-drain output with pull-up resistor, the pin cannot sink any current
Self Calibration Cycle	Initial time is 24 hours, later is 7 days

Absolute Maximum Ratings

Parameter	Minimum	Maximum	Units
Ambient Storage Temperature	-40	85	°C
Maximum Voltage Range	-0.3	5.5	V
Maximum Output Current from Active Output Pin	-25	+25	mA
Maximum Current on Input	-5	+5	uA
Maximum Load Voltage on UART Pin	-0.3	3.5	V

MTP40-F

NDIR CO₂ Sensor Module

◆ PIN Assignment

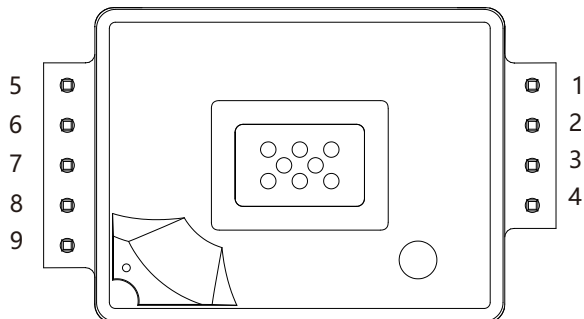

NO.	Name
1	Vin: 4.2V-5.5V
2	GND
3	Alarm
4	PWM/IIC-Detect
5	VCC-Out:3.3V
6	Host-TX/IIC-SDA
7	Host-RX/IIC-SCL
8	R/T
9	bCAL-in

◆ Terminals Description

Pin Function	Pin Description	Electrical Specification
Power Pins		
GND(Pin 2)	Power Supply Minus Terminal	
VIN(Pin1)	Supply Plus Terminal	Unprotected against reverse connection, input voltage range: 4.2V---5.5V
VCC-Out(Pin5)	The internal LDO output of the sensor is usually 3.3V+/-2%. Generally used for serial communication level conversion.	Output voltage: 3.3V+/-2% No overcurrent protection Maximum output current: 6mA
Communication Pins		
Host-TX(Pin6) /IIC-SDA	The TX pin of the UART of the host system is usually the TX of the customer's MCU, or the SDA of the IIC function.	Usually the communication level is 3.3V, and there is a 1K series current limiting resistor inside.In IIC mode, the pins have weak pull-ups resistor(Around 50KΩ)
Host-RX(Pin7) /IIC-SCL	The RX pin of the UART of the host system is usually the RX of the customer's MCU or the SCL of the IIC function.	Usually the communication level is 3.3V, and there is a 1K series current limiting resistor inside.In IIC mode, the pins have weak pull-up resistor(Around 50KΩ)
Input / Output		
PWM(Pin4)	PWM function,This pin is used for CO ₂ Concentration output.	The pin is an open-drain output mode, the load cannot be driven directly.the external pull-up resistor is necessary.
Alarm-OC(Pin3)	Alarm function: The pin is open-drain output mode. When the measured concentration exceeds 1000ppm, the output of this pin is high, when the concentration is lower than 800ppm, the output of this pin is low.	The pin is open-drain with a pull-up resistor and cannot directly drive the load.
R/T(Pin8)	This pin has two functions: 1.This pin is in open-drain output mode and can be directly connected to the direction enable pin of the RS,485 chip, and an external pull-up resistor is required . At this time, the modules Pin6 and Pin7 are UART functions. 2. UART/IIC function selection pin. This pin is grounded before power-on (grounding after power-on is invalid). Pin6 and Pin7 are functions of IIC.	When the pin is powered on, the input is With pull-up input mode, which can be left floating or grounded. When used as the Rs485 direction enable pin, it is in open-drain output mode and requires an external pull-up resistor.
bCAL-in(Pin9)	Manual calibration to control pin.	When the pin is powered on, the input has a pull-up resistor.

MTP40-F
NDIR CO₂ Sensor Module

◆ **Calibration function**

The module supports two calibration functions:

1.The MTP40 module is a precision optical module. Due to various reasons such as transportation, installation, welding, etc., the measurement of the module will cause a certain drift, making influence to the accuracy. The module has a built-in self-calibration algorithm, which can automatically correct the measurement error periodically, so that the module always maintains a relatively good measurement accuracy. The module self-calibration cycle defaults to 7 days (168 hours), which can be adjusted by instructions (24 hours to 720 hours).In order to make the module adjust the accuracy faster, the module will complete a self-calibration within 24 hours after power-on, and then perform periodic self-calibration according to the set cycle. In order to ensure the measurement accuracy of the sensor after calibration, please make sure that the CO₂ concentration in the working environment of the sensor can be close to the outdoor atmospheric level for at least a few hours within 24 hours of power-on and 7 days of continuous operation.

2.In addition to the self-calibration function, the sensor can also be manually calibrated to quickly restore accuracy. Pin9 (bCAL-in) of the sensor is the control pin for manual calibration. Pull this pin down for more than 2 seconds, and the sensor can complete the calibration. The reference concentration of this calibration function is the CO₂ concentration in the outdoor atmosphere, generally around 400PPM. To use this function, please place the sensor in an environment close to the outdoor atmospheric with CO₂ concentration, such as a relatively ventilated place. After power on, let it stay for at least 20 minutes. Then pull down Pin9 (bCAL-in) for more than 2 seconds to complete the calibration. Besides, the sensor also supports software instructions to calibrate. For details, please check the chapter of communication protocol instructions.

◆ **Alarm Function**

The MTP40 module supports the alarm function, which is output through the Alarm-OC pin. When the measured CO₂ concentration value>1000PPM, the Alarm-OC pin outputs a high level. When the measured CO₂ concentration value is less than 800PPM, the Alarm-OC pin outputs a low level. Note that the Alarm-OC pin is configured as an open drain output mode, so it has only a weak drive capability and an external pull-up resistor is required when in use. If an error occurs in the module, the Alarm-OC pin will always remain high level. Refer to the usage method as shown on the right.

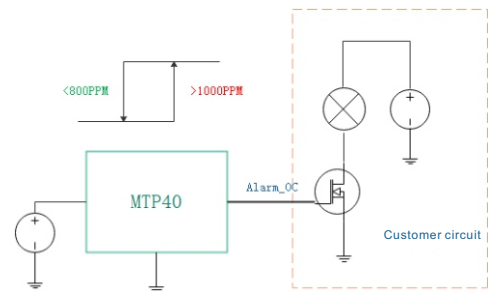

◆ **Communication Protocol**

Serial Communication

Baud rate of Serial communication is 9600 bps.
The definition of serial communication packet:

1. Protocol Format:

Frame format description :

Numeric field	Length	Description
Frame Header	2	Fixed to 0X42,0X4D
Instruction byte	1	Instruction definition or sensor type definition
Command byte	2	Specific command word
Data length	2	Big endian
Data	n	Big endian
Checksum	2	The cumulative sum of all bytes from the frame head to the last byte of data

The following protocol is applied in the product series of gas sensors,Instruction byte is 0xA0.

Description of Command byte:

Command byte	Description
0x0001	Set air pressure parameters (It is defaulted to 1013.0hPa)
0x0002	Read the currently set air pressure value
0x0003	Read gas concentration value
0x0004	Single point correction function(With Reference concentration)
0x0005	Single point correction read status
0x0006	Disable or enable self-calibration

MTP40-F NDIR CO₂ Sensor Module

0x0007	Read self-calibration status
0x0008	Read the self-calibration period(hours)
0x0009	Set the self-calibration period(hours)

2. Basic Control Protocol

Function name		Frame Header	Instruction byte	Command byte	Data length	Data	Checksum
Set air pressure parameters	Send by MCU	0x42 0x4d	0xA0	0x0001	0x00 0x02	The range of atmospheric pressure is 700-1100 (16bit integers).	Checksum
	Return by Module	0x42 0x4d	0xA0	0x0001	0x00 0x00		Checksum
Read the current pressure value	Send by MCU	0x42 0x4d	0xA0	0x0002	0x00 0x00		Checksum
	Return by Module	0x42 0x4d	0xA0	0x0002	0x00 0x02	The atmospheric pressure (16bit integers)	Checksum
Read gas concentration value	Send by MCU	0x42 0x4d	0xA0	0x0003	0x00 0x00		Checksum
	Return by Module	0x42 0x4d	0xA0	0x0003	0x00 0x05	Gas concentration value(32bit integers) and Data valid flag (8bit) 0x00: Valid; 0xFF: the data is unavailable	Checksum
Single point correction function (with reference concentration)	Send by MCU	0x42 0x4d	0xA0	0x0004	0x00 0x04	Reference concentration range: 0x2000(32 bit integers)	Checksum
	Return by Module	0x42 0x4d	0xA0	0x0004	0x00 0x01	0x01: Calibration starts 0xff: Calibration is wrong	Checksum
Read single point correction status	Send by MCU	0x42 0x4d	0xA0	0x0005	0x00 0x00		Checksum
	Return by Module	0x42 0x4d	0xA0	0x0005	0x00 0x01	0x00: Calibration is complete 0x01: Calibration is continuing	Checksum
Enable or disable self-calibration	Send by MCU	0x42 0x4d	0xA0	0x0006	0x00 0x01	0x00: Enable self-calibration 0xff: Disable self-calibration	Checksum
	Return by Module	0x42 0x4d	0xA0	0x0006	0x00 0x00		Checksum
Read self-calibration status	Send by MCU	0x42 0x4d	0xA0	0x0007	0x00 0x00		Checksum
	Return by Module	0x42 0x4d	0xA0	0x0007	0x00 0x01	0x00: Enable self-calibration 0xff: Disable self-calibration	Checksum
Read the self-calibration period	Send by MCU	0x42 0x4d	0xA0	0x0008	0x00 0x00		Checksum
	Return by Module	0x42 0x4d	0xA0	0x0008	0x00 0x02	the self-calibration period range: 24-720h	Checksum
Set the self-calibration period	Send by MCU	0x42 0x4d	0xA0	0x0009	0x00 0x02	the self-calibration period range: 24-720h	Checksum
	Return by Module	0x42 0x4d	0xA0	0x0009	0x00 0x01	00: Correct operation; 01: It is not acceptable if value is less than 24h; 02: It is not acceptable if the value is more than 720h	Checksum

MTP40-F

NDIR CO₂ Sensor Module

3. Quick Guide:

①Set air pressure parameters

Send: 0x42 0x4D 0xA0 0x00 0x01 0x00 0x02 0x03 0xF5 0x02 0x2A

Device	Phase	Data	Description	Cmd.Phase.Ofs(rep)
43	OUT	42 4d a0 00 01 00 02 03 f5 02 2a	BM.....*	1.1.0
43	IN	42 4d a0 00 01 00 00 01 30	BM.....0	2.1.0

0x03F5 is Hexadecimal of 1013

②Read the current pressure value

Send:0x42 0x4D 0xA0 0x00 0x02 0x00 0x00 0x01 0x31

Device	Phase	Data	Description	Cmd.Phase.Ofs(rep)
43	OUT	42 4d a0 00 02 00 00 01 31	BM.....1	1.1.0
43	IN	42 4d a0 00 02 00 02 03 f5 02 2b	BM.....+	2.1.0

③Read gas concentration value

Send:0x42 0x4D 0xA0 0x00 0x03 0x00 0x00 0x01 0x32

Data valid bit is 0xFF,the data is unavailable:

Device	Phase	Data	Description	Cmd.Phase.Ofs(rep)
43	OUT	42 4d a0 00 03 00 00 01 32	BM.....2	1.1.0
43	IN	42 4d a0 00 03 00 05 00 00 00 00 ff 02 36	BM.....6	2.1.0

◆ IIC Instruction Descriptions

The module operates in IIC slave mode and can be connected to an external MCU with a pull-up resistor inside the module.

The slave address is: 0x32 (7-bit address)

The write operation address is: 0x64

The read operation address is: 0x65

Host sending timing:

- 1.Send a start signal;
- 2.Send an address to write(slave address + R/W=0x64) and check responses;
- 3.Send a read command (0x03) and check the responses;
- 4.Send a stop signal;
- 5.Send a start signal;
- 6.Send an address to read (slave address + R/W(1)=0x65) and check responses;
- 7.Read 3 bytes from the module and send responses;
- 8.Send a stop signal.

The 3-byte data received is described as follows:

CO ₂ Concentration		Data Valid Byte
High Concentration Byte	Low Concentration Byte	0x00/0xFF

Attention:

CO₂ concentration = high byte of CO₂ concentration*256 + low concentration byte

Data valid byte, 0x00 means data is valid, 0xFF means data is invalid.

MTP40-F NDIR CO₂ Sensor Module

◆ PWM Function Descriptions

The cycle of the PWM is 1004ms;
 High level output 2ms in the initial stage;
 The central cycle is 1000ms;
 Low level output 2ms at the end stage.
 Calculation formula for obtaining the current CO₂

Concentration value through PWM:
 $C_{ppm} = 2000 * (TH - 2ms) / (TH + TL - 4ms)$;
 Cppm is the calculated CO₂ concentration value, the unit is ppm;
 TH is the time when the output is high in an output cycle;
 TL is the time when the output is low in one output cycle.

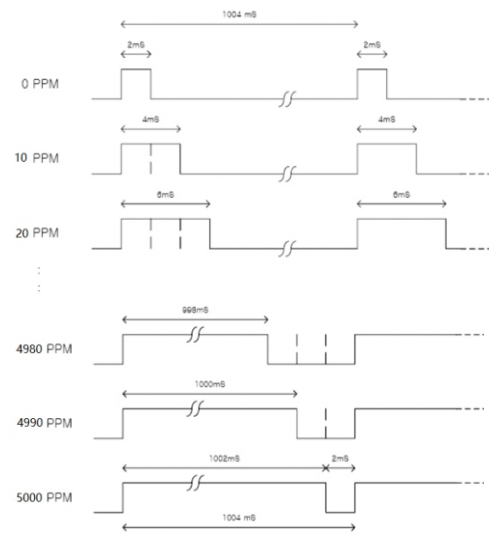

◆ Version

Date	Version	Changes
Jun.2, 2020	1.00	Initial
Aug.30, 2020	1.10	The alarm values were edited.