

MS6252A

# Digital Anemometer

## Operation's Manual

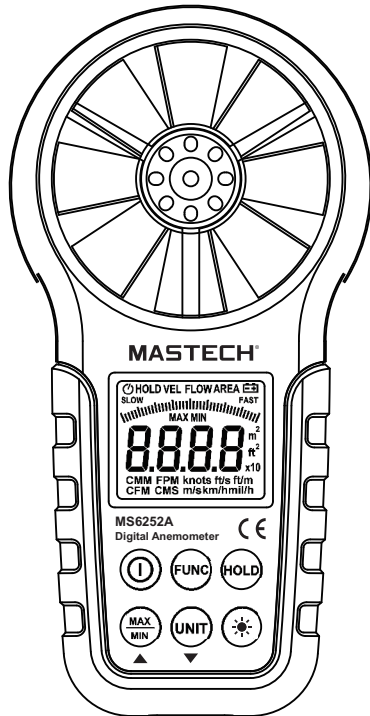

---

## CONTENTS

|                                   |          |
|-----------------------------------|----------|
| <b>1. SAFETY INFORMATION.....</b> | <b>1</b> |
| 1.1 Preparation.....              | 1        |
| 1.2 Usage.....                    | 1        |
| 1.3 Marking.....                  | 1        |
| 1.4 Maintenance.....              | 2        |
| <b>2. DESCRIPTION.....</b>        | <b>3</b> |
| 2.1 Part name.....                | 3        |
| 2.2 Button description.....       | 6        |
| 2.3 Sign definition.....          | 7        |
| <b>3. SPECIFICATION.....</b>      | <b>8</b> |
| 3.1 General .....                 | 8        |
| 3.2 Technique data.....           | 9        |

---

## CONTENTS

|   |           |
|---|-----------|
| <b>4. OPERATING GUIDANCE.....</b>         | <b>11</b> |
| 4.1 Power On/Off.....                     | 11        |
| 4.2 Reading hold .....                    | 11        |
| 4.3 Backlight function.....               | 11        |
| 4.4 Wind speed measurement.....           | 12        |
| 4.5 Wind speed unit selection.....        | 12        |
| 4.6 Area setting.....                     | 12        |
| 4.7 Air volume measurement.....           | 13        |
| 4.8 Air volume unit selection.....        | 13        |
| 4.9 Use tripod connection receptacle..... | 13        |
| 4.10 Replace battery.....                 | 14        |
| <b>5. ATTACHMENTS.....</b>                | <b>14</b> |

## 1. SAFETY INFORMATION

Please read carefully the following safety information before usage and maintain this anemometer while using it according to operating guidance, otherwise, the anemometer may be damaged. The anemometer will provide satisfactory services to you if you use and protect it appropriately.

### 1.1 Preparation

- 1.1.1 Please check for damage during transportation after receiving the anemometer.
- 1.1.2 If it should be stored and shipped under hard conditions, please confirm that whether the meter is damaged.

### 1.2 Usage

- 1.2.1 The meter should be used in the range of specified ambient temperature and humidity.
- 1.2.2 If you notice any abnormality or failure, it should stop using.
- 1.2.3 Don't store or use the meter under the conditions of direct sunlight, high temperature and high humidity.
- 1.2.4 Don't touch the fan blades with excessive force.
- 1.2.5 Don't directly expose the blades in the hard light to avoid reading error.

### 1.3 Marking

The **CE** mark indicates compliance with EMC requirements.

## Important Safety Information

### 1.4 Maintenance

- 1.4.1 Repair or maintenance should be implemented by trained personnel.
- 1.4.2 If there is dust on the fan blade, please blow it with clean air or scrub gently with a damp cloth and mild detergent.
- 1.4.3 Clean the meter with a damp cloth and mild detergent. Don't use abrasive material or solvent.
- 1.4.4 The meter should be powered off when it is not in use.
- 1.4.5 The meter will consume small current, about  $\leq 5\mu\text{A}$ , after shutdown. If the meter is not to be used for a long period, batteries should be removed to prevent damaging the meter.

## 2. DESCRIPTION

- This meter is a digital anemometer for measuring the ambient temperature, humidity, dew point temperature, wet bulb temperature, wind speed, and air volume.
- This meter is a portable, professional measuring instrument with large-screen LCD and backlight, multi-unit switching functions.
- This meter can be used for hand-held or fixed measurement.
- This meter has the functions of reading hold, maximum, minimum, etc.
- It has a low battery indicator and USB real time data uploading functions.

### 2.1 Part name

- (1) Fan
- (2) LCD
- (3) "FUN" — Function switching button
- (4) "⊙" — Power switch
- (5) "UNIT" — Unit switching button
- (6) Maximum/Minimum button
- (7) "HOLD" hold display
- (8) "☀" — Backlight Button
- (9) Fan retaining bolt hole
- (10) Connection hole for fixing measurement bracket
- (11) Battery housing cover retaining bolt hole
- (12) Battery cover

## FRONT PANEL

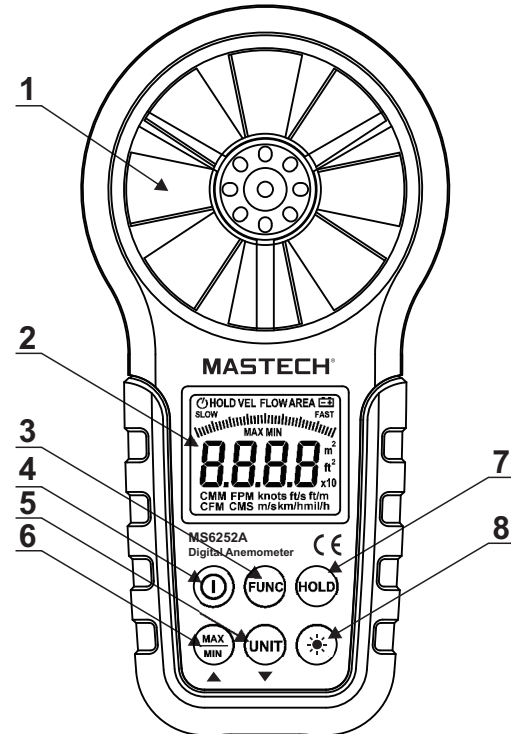

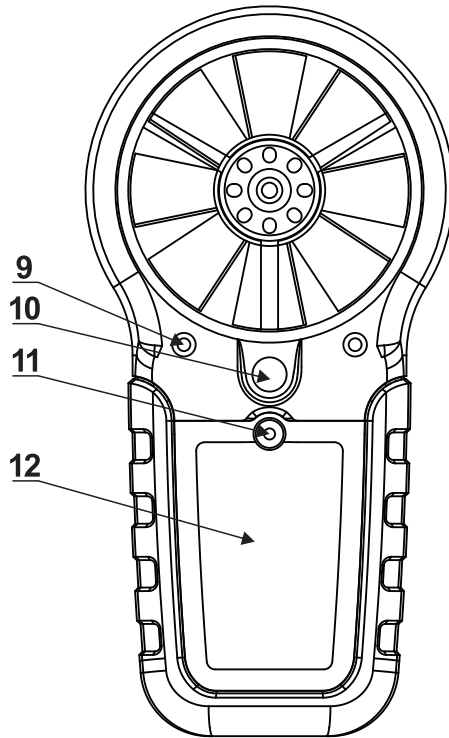

## BACK PANEL





05

## 2.2 Button description

-  Button  
Switch for meter powering on/off.
-  Button  
Switch for turning on/off the backlight.
- **HOLD** Button  
Hold display of LCD.
- **FUN** Button  
It is used for switching among the functions of wind speed measurement, area setting and air volume measurement. Long press for three seconds to enable or disable "Auto Power-Off" function.
- **MAX/MIN** Button  
Switch maximum/minimum/normal mode, long press to exit.
- **UNIT** Button  
Switch unit, area (m<sup>2</sup>, ft<sup>2</sup>), long press to switch (°C, °F)  
Wind speed (m/s, km/h, mil/h, ft/m, ft/s, knots),  
Air volume (CMS, CMM, CFM).

06

## 2.3 Sign definition

|   |  |
|---|--|
|  | Indicates Auto Power-Off status                              |
| <b>HOLD</b>   | Reading hold state   |
| <b>VEL</b>  | Wind speed measurement state                                 |
| <b>FLOW</b>   | Air volume measurement state                                 |
| <b>AREA</b>   | Area setting required by air volume                          |
| <b>SLOW</b>   | Indicates current wind-speed <5m/s                           |
| <b>FAST</b>   | Indicates current wind-speed >5m/s                           |
| <b>MAX</b>  | Displays maximum after entering maximum/minimum mode         |
| <b>MIN</b>  | Displays minimum after entering maximum/minimum mode         |
| <b>m<sup>2</sup></b>  | Indicates that the current area setting unit is square meter |
| <b>ft<sup>2</sup></b>   | Indicates that the current area setting unit is square foot  |
| <b>CMM</b>  | Cubic meters per minute                                      |
| <b>CMS</b>  | Cubic meters per second                                      |
| <b>CFM</b>  | Cubic meters per minute                                      |
| <b>knots</b>  | Nautical miles per hour, 1850 meters per hour                |
| <b>ft/s</b>   | Feet per second  |
| <b>ft/m</b>   | Feet per minute  |
| <b>m/s</b>  | Meters per second  |
| <b>Km/h</b>   | Kilometers per hour  |
| <b>mil/h</b>  | Nautical miles per hour                                      |
|  | Low battery indicator  |

## 3. SPECIFICATION

The meter should be recalibrated under the condition of 18°C~28°C, relative humidity <75% every year.

### 3.1 General

3.1.1 Work height: Maximum 2000m

3.1.2 Work mode:

Frequency of wind speed conversion

3.1.3 Display: LCD

3.1.4 Maximum show value: 9999

3.1.5 Sampling time: About 0.4s/time.

3.1.6 Low battery indicator:  sign displays on LCD.

3.1.7 Work power: 1×9V 6F22 battery.

3.1.8 Operation environment:

Relative humidity—0~85%RH,  
no moisture condensation  
Temperature—0°C~40°C,  
no moisture condensation

3.1.9 Detector (fan) operation environment:

Relative humidity— 0~95%RH,  
no moisture condensation.  
Temperature—-20°C~80°C,  
no moisture condensation.

3.1.10 Storage environment:

Relative humidity— 0~80%RH,  
no moisture condensation  
Temperature—-10°C~50°C,  
no moisture condensation

3.1.11 Dimensions:165X85X38mm.

3.1.12 Weight: About 168g

### 3.2 Technique data

Ambient temperature: 23±5°C, Relative humidity: <75%

#### 3.2.1 m/s

| Measuring range   | Resolution | Accuracy                        |
|-------------------|------------|---------------------------------|
| 0.80 ~ 30.00 m/s  | 0.01 m/s   | ±(2.0% reading + 50 characters) |
| 30.00 ~ 40.00 m/s |            | For reference only              |

#### 3.2.2 km/h

| Measuring range    | Resolution | Accuracy                        |
|--------------------|------------|---------------------------------|
| 2.88~108.00 km/h   | 0.01km/h   | ±(2.0% reading + 50 characters) |
| 108.0 ~ 144.0 km/h | 0.1km/h    | For reference only              |

#### 3.2.3 ft/s

| Measuring range     | Resolution | Accuracy                        |
|---------------------|------------|---------------------------------|
| 2.62~ 98.50 ft/s    | 0.01 ft/s  | ±(2.0% reading + 50 characters) |
| 98.50 ~ 131.20 ft/s |            | For reference only              |

#### 3.2.4 knots

| Measuring range   | Resolution | Accuracy                        |
|-------------------|------------|---------------------------------|
| 1.6 ~ 58.30 knots | 0.01knots  | ±(2.0% reading + 50 characters) |
| 58.30~77.70 knots |            | For reference only              |

#### 3.2.5 mile/h

| Measuring range    | Resolution | Accuracy                       |
|--------------------|------------|--------------------------------|
| 1.8 ~ 67.20 mile/h | 0.01mile/h | ±(2.0% reading + 5 characters) |
| 67.20~90.00 mile/h |            | For reference only             |

#### 3.2.6 ft/m

| Measuring range   | Resolution | Accuracy                       |
|-------------------|------------|--------------------------------|
| 157.5 ~ 5900 ft/m | 1ft/m      | ±(2.0% reading + 5 characters) |
| 5900 ~ 7874 ft/m  |            | For reference only             |

#### 3.2.7 Air volume unit

|     |         |                                  |
|-----|---------|----------------------------------|
| CFM | 0~999.9 | (Area) 0 - 9.999 ft <sup>2</sup> |
| CMM | 0~999.9 | (Area) 0 - 9.999 m <sup>2</sup>  |
| CMS | 0~99.99 | (Area) 0 - 9.999 m <sup>2</sup>  |

## 4. OPERATING GUIDANCE

### 4.1 Power On/Off

Press the “” key to turn on or off the anemometer power.



### 4.2 Reading hold

In the measurement process, if the reading should be kept, press “**HOLD**” key to lock the reading, and display the **HOLD** symbol; press it again to unlock.



#### Note:



In the reading hold state, “**FUN**”, “**MAX/MIN**” and “**UNIT**” keys are invalid.

### 4.3 Backlight

In the measurement process, if the ambient light is too dark to read, you can press “” key to open the backlight. Backlight timer is set to 15 seconds. During this period, you can press “” key again to turn off backlight at any time.

#### Note:

- The luminous body of backlight is LED with large operating current. Frequently using backlight will shorten battery life. Do not use backlight when unnecessary.
- When the battery voltage  $\leq 7V$ , the  (low battery) symbol will show on the display. However, in the case of using the backlight, if the battery voltage  $\geq 7V$ , the battery voltage drops because of its larger operating current, “” symbol may show (when

“” symbol is showing, the accuracy of the measurement can't be guaranteed). At this moment, you needn't replace battery until the “” symbol display again under normal use condition without using backlight.

### 4.4 Wind speed measurement

Place the detector (fan) into the test environment, “**VEL**” symbol will display on the screen, measurement is done with the fan surface perpendicularly to the wind direction.

#### Note:

1. If the detector (fan) is not aiming at the wind direction, which will bring the measurement error.
2. For steady wind, the detector (fan) will get maximum reading when it is aiming at the wind direction.

### 4.5 Wind speed measurement

When using the meter to measure air volume, you can press “**UNIT**” key to select the measurement unit you required (m/s, km/h, mill/h, ft/m, ft/s, knots).

### 4.6 Area setting

To measure air volume, you should first determine the area of air flue to be, area input steps are shown as following:

- ① Press “**FUN**” key to make “**AREA**” display on the screen.
- ② Use the “**MAX/MIN**” and “**UNIT**” keys to adjust value and unit, after adjusting area unit (m<sup>2</sup>, ft<sup>2</sup>), then press “**MAX/MIN**” key. There should be an



audible buzz, indicating that area input is completed and settings are saved.

- ③ To change the area setting, please repeat the step ②.

#### 4.7 Air volume measurement

Place the detector (fan) into the test environment. Use the "FUN" key to set the meter to the Air volume measurement mode; the "FLOW" symbol should display on the screen.

Measurement is done with the fan surface perpendicular to the wind direction.

##### Note:

1. If the detector (fan) is not aligned in the wind direction, the measurement can be skewed.
2. For steady wind, the detector (fan) will get maximum reading when it is aiming at the wind direction.

#### 4.8 Air volume unit selection

When using the meter to measure air volume, you can press the "UNIT" key to select the measurement unit your required (CMS, CMM, CFM).

#### 4.9 Using tripod connection receptacle

##### 4.9.1

When necessary, the meter can be fixed on a tripod.

##### 4.9.2

When necessary, the meter can be used by hang.

#### 4.10 Replacing battery

- 4.10.1 If the "🔋" sign appears, this indicates that the battery should be replaced.
- 4.10.2 Power off the meter and remove the battery cover.
- 4.10.3 Replace the old battery.
- 4.10.4 Install the battery cover properly.

#### 5. ATTACHMENTS

|                      |                     |          |
|----------------------|---------------------|----------|
| (1) Battery          | 9V, NEDA 1604, 6F22 | 1pcs     |
| (2) Detector Bracket |                     | Optional |
| (3) Packaging Bag    |                     | 1pcs     |
| (4) Operation Manual |                     | 1pcs     |



R-00-05-0647