

Bench Multimeter

Users Manual

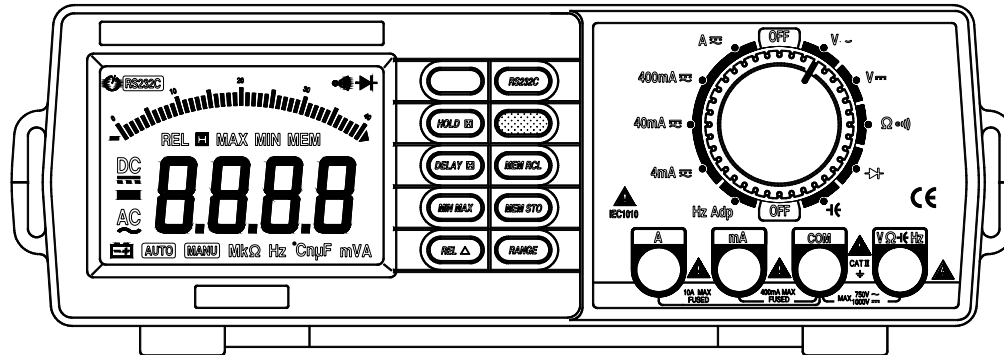

Introduction

This manual contains information and warnings, which must be followed to ensure safe operation and retain the meter in safe condition.

WARNING

READ "SAFETY INFORMATION" BEFORE USING THE BENCH MULTIMETER

This multimeter is a portability 4000-count instrument that is designed for use in the laboratory, field servicing, and at home, and any circumstance. This multimeter feature compact design with rounded corners for easy handling and has a rugged case in shock resistant and fire-retardant. And electronic overload protection for all functions and ranges.

Unpacking and Inspection

Upon removing your new Bench Multimeter from its packing, you should have the following items:

1. Bench Multimeter
2. Test Leads set (one black, one red)
3. Carrying strap
4. Power Cord
5. Instruction Manual
6. RS232C Cable (to buy by user optional)

If any of the above items are missing or are received in a damaged condition, please contact the distributor from whom you purchased the unit.

Table of Content

CHAPTER

Safety Precautions	IV
Safety Information	V
1. A Quick Tour	1-1
Symbol Explanation	1-1
Instrument Layout	1-2
Using the Rotary Switch	1-5
Using the Hardkeys	1-6
Buzzer Output	1-10
Low-Battery Indication	1-10
2. Making Measurements	2-1
Introduction	2-1

Measuring DC Volts	2-2
Measuring AC Volts	2-4
Measuring AC and DC Amps	2-6
Measuring AC and DC Milliamps	2-8
Measuring Capacitance	2-10
Measuring Frequency and Adaptive	2-12
Testing Diodes	2-14
Measuring Resistance and Continuity	2-16
3. Specifications	3-1
General Specifications	3-1
Resolution and Accuracy	3-3
4. Maintenance	4-1
Introduction	4-1
Replacing the Battery	4-1
Replacing the Fuse	4-2
Replacing the Power Fuse	4-3
Other Note	4-4

Safety Precautions

Injury or death can occur even with low voltages and low current. It is extremely important that you read these safety information before using your multimeter. Follow all safety practices and proper operating procedures for equipment being tested.

1. Exercise extreme caution when: Measuring voltage above 20 volts, measuring current greater than 10 mA, measuring AC power line with inductive loads, measuring AC power line during electrical storms.
2. Always inspect your multimeter, test leads and accessories for sign of damage or abnormality before every use. If any abnormal conditions exist (i.e., broken or damaged test leads, cracked case, display not reading, etc.), do not attempt to take measurements.
3. Never ground yourself when taking electrical measurements. Do not touch exposed metal pipes, outlets, fixtures, etc., which might be at ground potential. Keep your body isolated from ground by using dry clothing, rubber shoes, rubber mats, or any approved insulating material.
4. Never touch exposed wiring, connections, test probe tips, or any live circuit conductors when attempting to make measurements.
5. Never replace the protective fuse inside the multimeter with a fuse other than the specified or approved equal fuse. Replace only with same type of fuses. To avoid electrical shock, disconnect the test leads and any input signals before replacing the fuses.
6. Replace only with same type of battery. To avoid electrical shock, Disconnect power cord from live power source, and the test leads and any input signals before replacing the battery.

-
7. Do not operate this multimeter in an explosive atmosphere (i.e., in the presence of flammable gases or fumes, vapor or dust.)
 8. Measuring voltage that exceeds the limits of the multimeter may damage the meter and expose the operator to a shock hazard. Always recognize the meter voltage limits as stated on the front of the meter.
 9. Never apply more than 500V DC between the COM jack and earth ground.
 10. Never touch a voltage source when the test leads are plugged into a current jack.
 11. When testing for the presence of voltage or current, make sure the voltage or current ranges are functioning correctly. Take a reading of a known voltage or current before assuming a zero reading indicates no current or voltage.
 12. Do not attempt calibration or service unless trained and another person capable of rendering first aid and resuscitation is present.
 13. Remember: Think Safety, Act Safely.

Safety Information

The multimeter complies with Protection Class II, Overvoltage CAT II of the IEC61010-1(EN61010-1). Pollution degree 2 in accordance with IEC-664 indoor use. If the equipment is used in a manner not specified, the protection provided by the equipment may be impaired.

Chapter 1

A Quick Tour

Symbol Explanation



Caution



Caution, Possibility of electric shock



Earth (ground) TERMINAL



AC-Alternating current



DC-Direct current



Audible continuity



Equipment protected throughout by Double Insulation (Protection Class II)

Instrument Layout

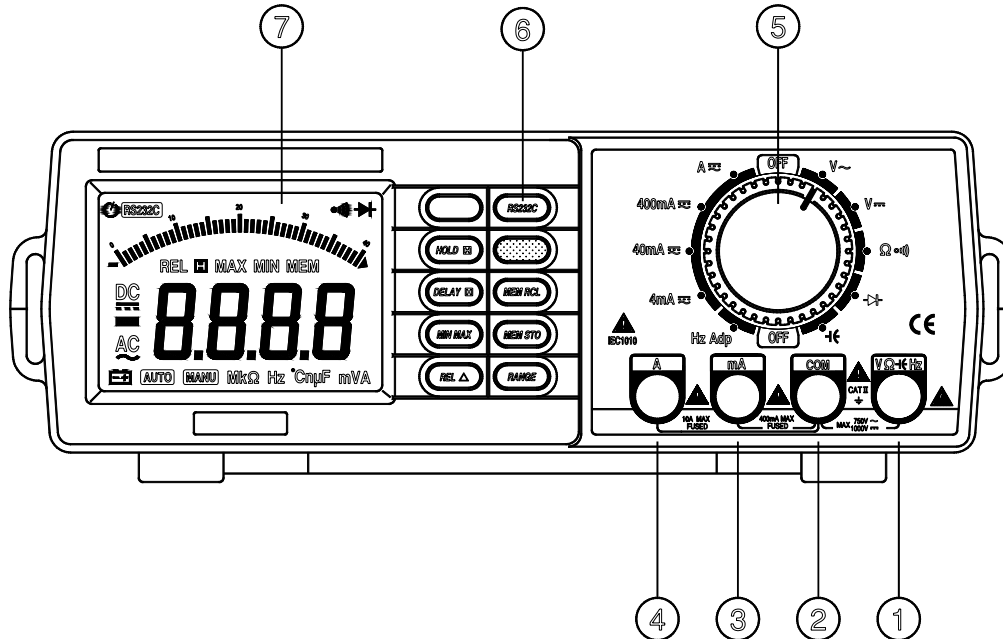

Figure 1-1. Bench Multimeter Features (Forward)

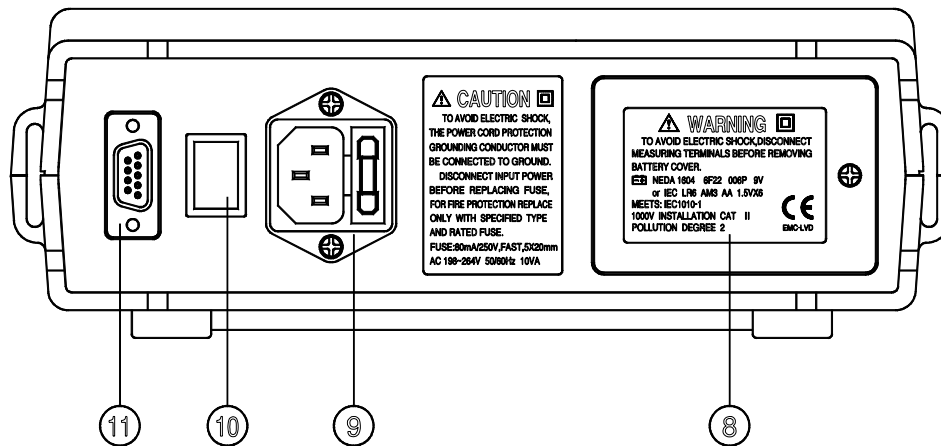

Figure 1-2. Bench Multimeter Features (Backward)

1. **V Ω \rightarrow Hz** Volt, Ohms, Diode, Frequency Input Terminal

This is the positive input terminal for all function except current measurements. Connection is made to using the Red test lead.

2. **COM** Common Terminal

This is the negative (ground) input terminal for all measurement modes. Connection is made to using the Black test lead.

3. **mA** Milliamp Input Terminal

This is the positive input terminal for current measurement (AC or DC) up to 400 mA. Connection is made to using the Red test lead.

4. **A** 10 Amperes Input Terminal

This is the positive input terminal for current measurement (AC or DC) up to 10A. Connection is made to using the Red test lead.

5. **Function / Range Selector Rotary Switch**

This rotary switch selects the function, and selects the desired range.

6. **Function / Range Selector Buttons**

This buttons selects the function, and selects the desired range.

7. The LCD Display

The LCD display indicates the measured value of a signal, function mode, and annunciator.

8. The Battery Cover

9. Supply Power Inlet with Fuse

This switch is used to turn AC Power on or off. When the AC Power is on, the DC Power is auto turned off.

 **WARNING**

To avoid user for injury and the multimeter for damage, the voltage value of AC power must be examined with same the power requirements of multimeter before connect power cord to live power source and the switch is turned on.

10. The power switch

11. RS232C Socket (to buy by user optional)

Using the Rotary Switch

Turn the multimeter on by rotating the rotary switch to any function.

Using the Buttons

The Buttons are push type switch. The functions are as follows:

1.  **BACKLIGHT Button**

You can turn the backlight on or off by press  button. When the battery is turned, the backlight turned on over either second, the backlight is auto turn off.

2.  **FUNCTION SELECTOR Button**

In the range of Measuring Resistance and Continuity, The Resistance or Continuity measurement is changed alternatively by each press  button.

In the range of Measuring Frequency and Adapted Test, The Frequency or Adaptive measurement is changed alternatively by each press  button.

In the range of Measuring DC and AC Amps, The DC Amps or AC Amps measurement is changed alternatively by each press  button.



In the range of Measuring DC and AC Milliamps, The DC Milliamps or AC Milliamps measurement is changed alternatively by each press  button.

3.  DateHold: **HOLD Button**

Press  button to toggle in and out of the Date Hold mode, except if multimeter is already in the Min/Max Recording Hold mode.



In the Date Hold mode, the "  " annunciator is displayed and the last reading is held on the display, the beeper emits a tone.

Pressing  button when multimeter is in the Date Hold mode causes it to exit Date Hold and enter the Min/Max Recording Hold mode.



In the Min/Max Recording Hold mode, press  button stop the recording of readings, press  again to resume recording.

However, the multimeter is operating even though in Date Hold status, therefore, the buzzer sound is come out when occur the over range or continuity modes. And the range is also changed if it is in auto range.

4.  Delay Data Hold: **DELAY HOLD Button**

When  button is pressed over eight second, to toggle in and out of the Date Hold mode, and the "  " annunciator turns on or off.

5.  Min/Max Recording Hold: **MIN / MAX Button**

Press  button to enter the Min/Max Recording Hold mode. The minimum, maximum values are then reset to the present input, the readings are stored in memory, and the "  " annunciator turns on. Push the button to cycle through the minimum (**MIN**), the maximum (**MAX**), and present readings. The " **MIN** " or " **MAX** " annunciator turns on to indicate what value is being displayed.

In the Min/Max Recording Hold mode, press  button to stop the recording of readings, press again to restart recording. If recording is stopped, the minimum, maximum, or present values and analog display are frozen. In the Min/Max Recording Hold mode, when a new minimum value is exceeded the actual minimum readings or a new maximum value is overload, the minimum or maximum value will be held on the display, but the analog display continues to be active. In case of in the auto-range, the mode is held to just before range.

6.  Relative Display: **REL Button**

Press  button to enter the Relative Display mode, the " **REL** " annunciator turns on, zero the display, and store the displayed reading as a reference value.

In the Relative Display mode, the value shown on the LCD is always the difference between the stored reference value and the present reading. If the new reading is the same as the reference value, the display will be zero.

The bargraph is displayed absolute value, not relative value. And the over-range also occurs against the absolute value.

In case of the autorange, the range is held just before range.

Press and hold down the  button for over one second, to exit the relative mode.

7. **RANGE Button**

Press  button to select the Manual Range mode and turn off the " **AUTO** " annunciator.

In the Manual Range mode, each time the  button is pressed, the range (and the input range annunciator) increments, and a new value is displayed.

To exit The Manual Range mode and return to autoranging, press and hold down  button over one second. The " **AUTO** " annunciator turns back on.

The DC V, AC V, Resistance and Capacitance measurement are always first set to the auto range.

The frequency measurement is always set to the auto range.



The Continuity, Diode, ADP, DC A and AC A measurement are always fixed the range.

When power is turned-on, default range is selected.



8. Data Memory: **MEM STO Button**

Press  button to enter the Data Memory mode and turn on the " **MEM** " annunciator, all of display data is stored in the memory. The stored data can be read out and display on the LCD, then becomes the Data Recall Hold mode.

9. Data Recall Hold: **MEM RCL Button**



Press  button to enter the Data Recall mode, and turn on the " **MEM** " and "  " annunciator, The stored data can be read out and display on the LCD, then becomes the Data Recall Hold mode.

During the stored data in the memory display, the " **MEM** " annunciator is blinking. And the Data Recall Hold mode is released by pressing  button or  button.

-
10.  RS232C Button (The function of communication is optional by user.)
Press  button to enter the communication. You will find that the RS232C sign be it lit on the display.
Fixed one side of cable to the meter and connect the 9 pin's terminal of cable to communication port 1 or port 2 of personal computer.
Execute the software to take the data for you necessary.

Buzzer Output

2kHz buzzer sound is output in following cases:

1. When operate the key.
2. When occur the over-range. Except the measurement mode of Resistance (Ω), Frequency (**Hz**), Continuity () and Diode ().
3. When the continuity measurement result is less than 40 Ω .
4. When the relative mode is released.
5. When the mode is changed from manual to autorange by operating the  Please refer the timing chart for the timing.

Low Battery Indication

The "  " mark is displayed when the battery load voltage drops below accurate operating level.

Chapter 2 ***Making Measurements***

Introduction

 WARNING

To avoid user for injury and the multimeter for damage, the voltge value of AC power must be examined with same the power requirements of multimeter before connect power cord to live power source and the switch is turned on.

Before making any measurements always examine the multimeter and accessories used with the multimeter for damage, contamination (excessive dirt, grease, ect.) and defects. Examine the test leads for cracked or frayed insulation and make sure the lead plugs fit snugly into the multimeter jacks. If any abnormal exist do not attempt to make any measurements.

Measuring DC Volts

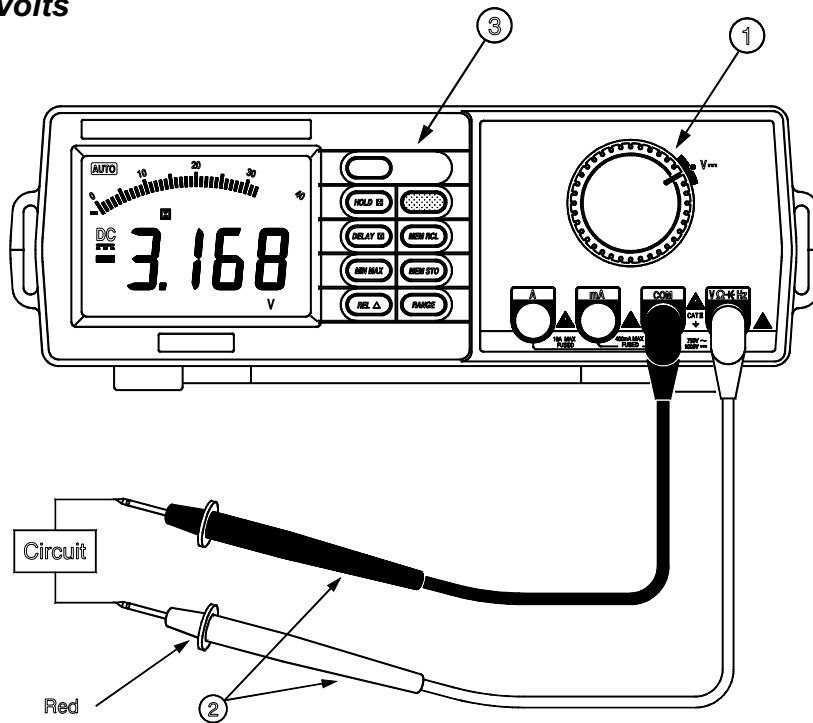



Figure 2-1. DC Volts Measurements

⚠ WARNING

To avoid possible electric shock, multimeter damage and/or equipment damage, do not attempt to take any voltage measurements if the voltage is above 1000V DC / 750V AC RMS. 1000V DC / 750V AC RMS are the maximum voltages that this multimeter is designed to measure.

- ①. Turn the Selector to Volts DC.
 - ②. Connect the leads as shown.
 - ③.  is not available in Volts DC; all other buttons can be used.
1. Insert the black and red test leads into the **COM** and **VΩ→Hz** input terminals respectively.
 2. Select the desired DC voltage range, or set automatic range.
 3. When the magnitude of the voltage to be measured is unknown, always start with the highest range.
 4. Connect the test lead tips in parallel with the circuit to be measured. Be careful not to touch any energised conductors. Note the reading.
 5. For DC voltage readings, the red lead tip should be connected to the positive side of the circuit, the black lead to the negative side. A minus sign on the left-hand side of the LCD will appear if the leads are connected the other way round.
 6. When all measurements are completed, disconnect the test leads from the circuit under test. Remove test leads from the multimeter.

Measuring AC Volts

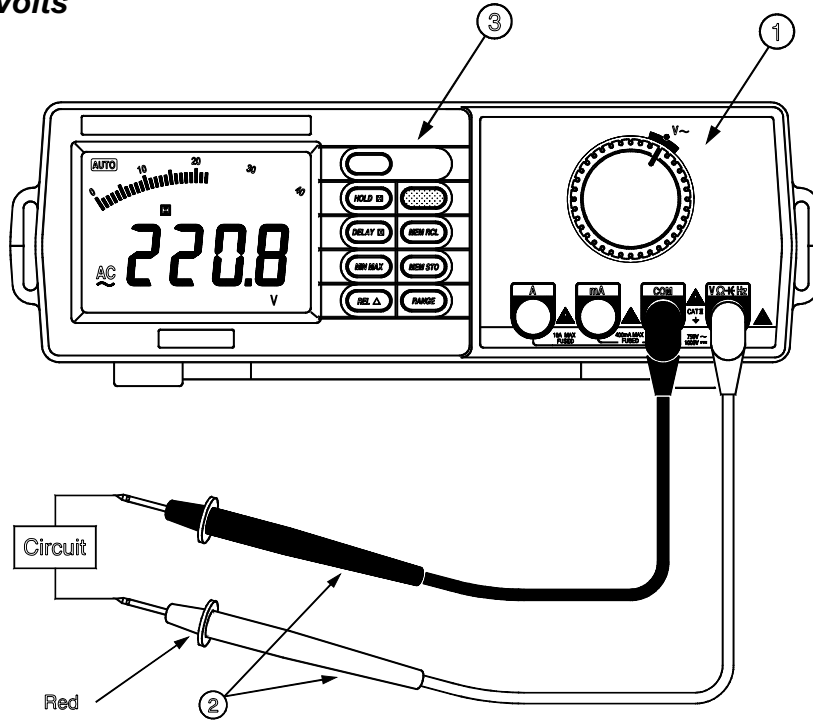



Figure 2-2. AC Volts Measurements

⚠ WARNING

To avoid possible electric shock, multimeter damage and/or equipment damage, do not attempt to take any voltage measurements if the voltage is above 1000V DC / 750V AC RMS. 1000V DC / 750V AC RMS are the maximum voltages that this multimeter is designed to measure.

- ①. Turn the Selector to Volts AC.
 - ②. Connect the leads as shown.
 - ③.  is not available in Volts AC; all other buttons can be used.
1. Insert the black and red test leads into the **COM** and **VΩ→Hz** input terminals respectively.
 2. Select the desired AC voltage range, or set automatic range.
 3. When the magnitude of the voltage to be measured is unknown, always start with the highest range.
 4. Connect the test lead tips in parallel with the circuit to be measured. Be careful not to touch any energised conductors. Note the reading.
 5. For DC voltage readings, the red lead tip should be connected to the positive side of the circuit, the black lead to the negative side. A minus sign on the left-hand side of the LCD will appear if the leads are connected the other way round.
 6. When all measurements are completed, disconnect the test leads from the circuit under test. Remove test leads from the multimeter.

Measuring DC and AC Amps

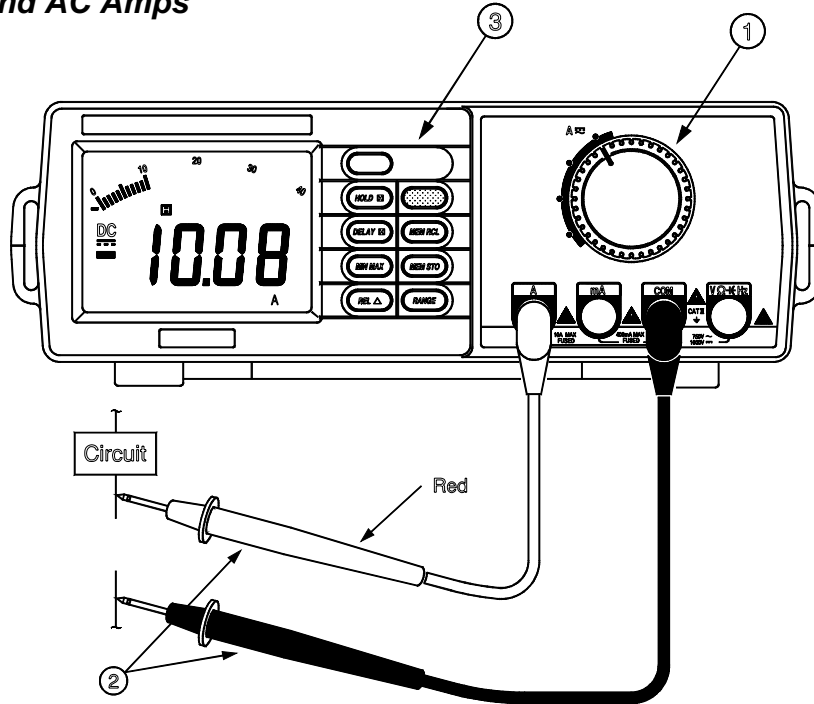



Figure 2-3. Amps Measurements

⚠ WARNING

Do not attempt to measure currents in high energy circuits. Use a current clamp for measurement needs >10A. The 10A input terminal is protected by a F15A/250V fast blow ceramic fuse.

- ①. Turn the Selector to DC and AC Amps.
- ②. Connect the leads as shown.
- ③.  is not available in DC and AC Amps; all other buttons can be used.

The DC or AC Amps measurement is changed alternatively by each press the button 

The DC and AC Amps Measurement is as follows:

1. Insert the black and red test leads into the **COM** and **A** input terminals respectively.
2. Turn off or disconnect the circuit to be measured from all power sources, connect the multimeter in series with the conductor in which the current to be measured flows.
3. Turn on power to the circuit under test. Note the reading,
4. After completing the measurement, turn off power to the circuit under test, disconnect the test leads from multimeter.
5. The DC and AC Amps measurement are always fixed the range.

Measuring DC and AC Milliamps

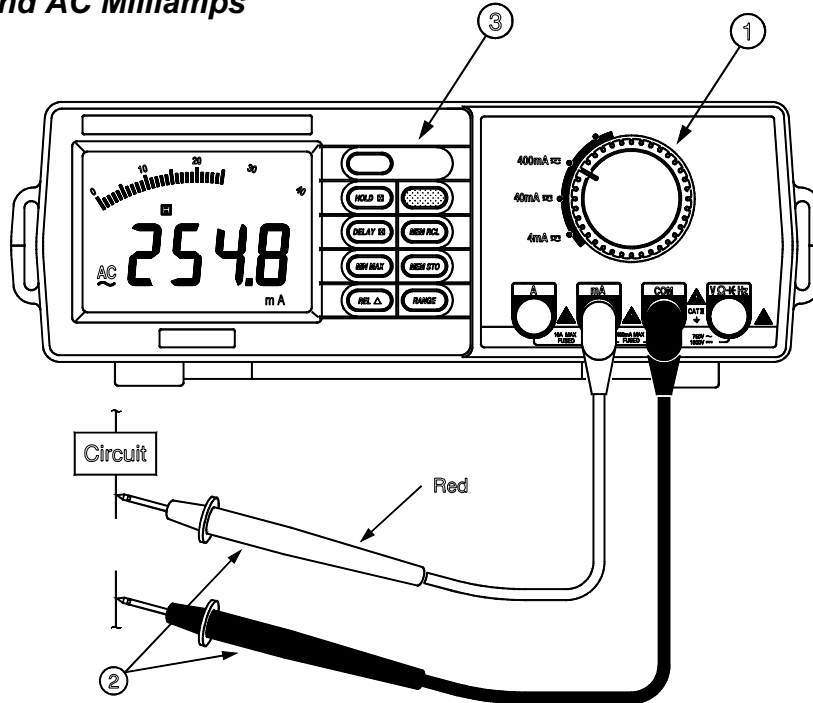



Figure 2-4. Milliamps Measurements

⚠ WARNING

Do not attempt to measure currents in high energy circuits. The mA input terminal is protected by a F500mA/250V fast blow fuse.

- ①. Turn the Selector to DC and AC Milliamps.
- ②. Connect the leads as shown.
- ③.  is not available in DC and AC Milliamps; all other buttons can be used.

The DC or AC Milliamps measurement is changed alternatively by each press the button  .

The DC and AC Milliamps Measurement is as follows:

1. Insert the black and red test leads into the **COM** and **mA** input terminals respectively.
2. Select the desired DC current range or AC current range.
3. Turn off or disconnect the circuit to be measured from all power sources, connect the multimeter in series with the conductor in which the current to be measured flows.
4. Turn on power to the circuit under test. Note the reading.
5. After completing the measurement, turn off power to the circuit under test, disconnect the test leads from multimeter.
6. The DC and AC Milliamps measurement are always fixed the range.

Measuring Frequency and Adaptive

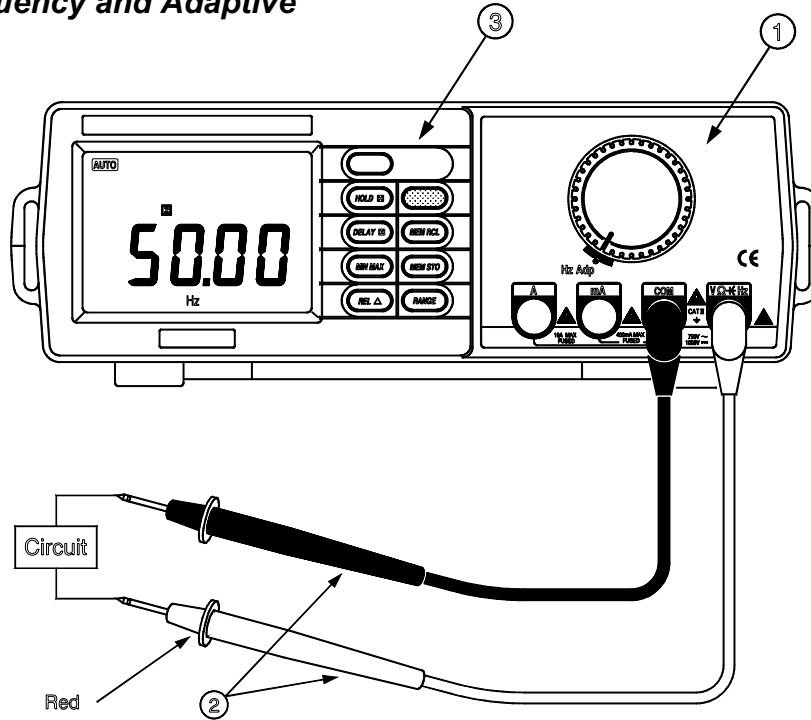



Figure 2-5. Measurement Frequency and Adaptive (ADP)

-
- ①. Turn the Selector to Frequency and Adaptive Measurement.
 - ②. Connect the leads as shown.
 - ③.  is not available in the Frequency and Adaptive Measurement; all other buttons can be used.

The Frequency and Adaptive Measurement are changed alternatively by each press the button  .

The Frequency Measurement is as follows:

1. Insert the black and red test leads into the **COM** and **VΩ→Hz** input terminals respectively.
2. In the Frequency Test, it is not necessary to know the range, as the multimeter will automatically range up or down to display the best resolution. Manual range is not available.
3. Determine that the amplitude level of the signal to be measured is not greater than the input voltage limit (250V DC/AC rms). The signal amplitude must also be greater than the sensitivity level.
4. Attach the probe tips to the points across which the frequency is to be measured, and read the result directly from the display.
5. The frequency range is always set to autorange.

The Adaptive (ADP) Measurement is as follows:

1. Connect ADP signal terminal (-) and (+) into the **COM** and **VΩ→Hz** input terminals respectively.
2. The ADP voltage is supplied to the multimeter directly. The result is displayed by 10 counts per 1mV.
3. The ADP Measurement is always fixed the range. The full range is 400mV DC voltage.

Measuring Capacitance

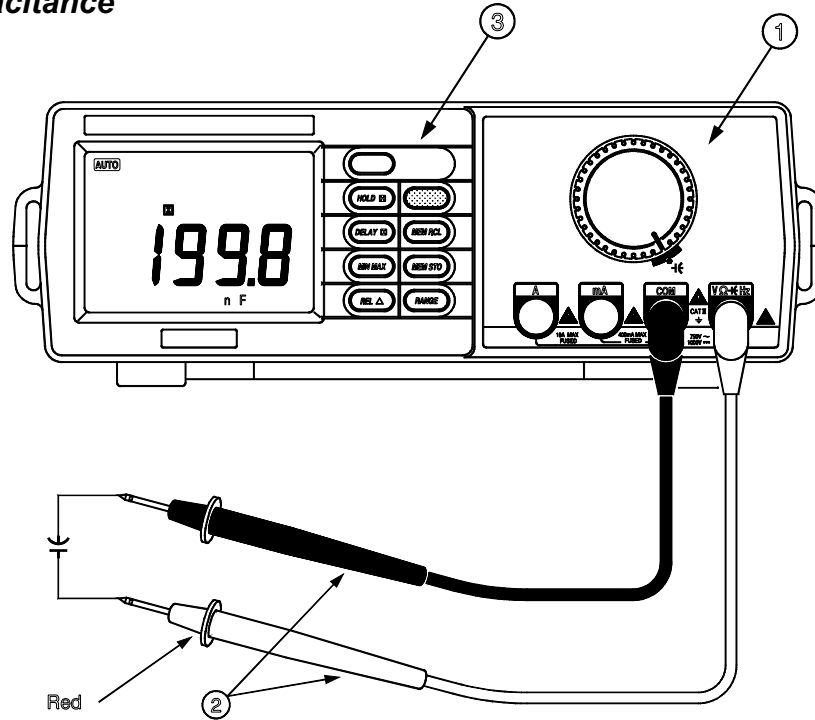



Figure 2-6. Capacitance Measurements

 **WARNING**

Turn off power to the device under test and discharge all capacitors.

- ①. Turn the Selector to Capacitance.
- ②. Connect the leads as shown: Insert the black and red test leads into the **COM** and **VΩ→Hz** input terminals respectively.
- ③  is not available in The Capacitance; all other buttons can be used.

The measuring capacitance is as follows:

1. Turn off power to the device under test and discharge all capacitors.
2. Discharge all voltage from the capacitor before measuring its capacitance value.
3. Set the capacitance range that gives the most accurate measurement reading or to select autorange.
4. Connect the alligator clips to capacitor leads or insert leads of the capacitor into multimeter measuring socket. Always observe polarity markings when measuring polarized capacitor.
5. Read capacitance value directly from display. The measurement accuracy of capacitors can be improved by first using the  (Relative mode) to zero the and automatically subtract the residual multimeter and test lead capacitance. Since the Relative mode also selects manual ranging.
6. Residual voltage charges on the capacitor, or capacitors with poor insulation resistance or poor dielectric absorption may cause measurement errors.

NOTE: A safe way to discharge a capacitor is to connect a 100kΩ resistor across the two capacitor leads.

Testing Diodes

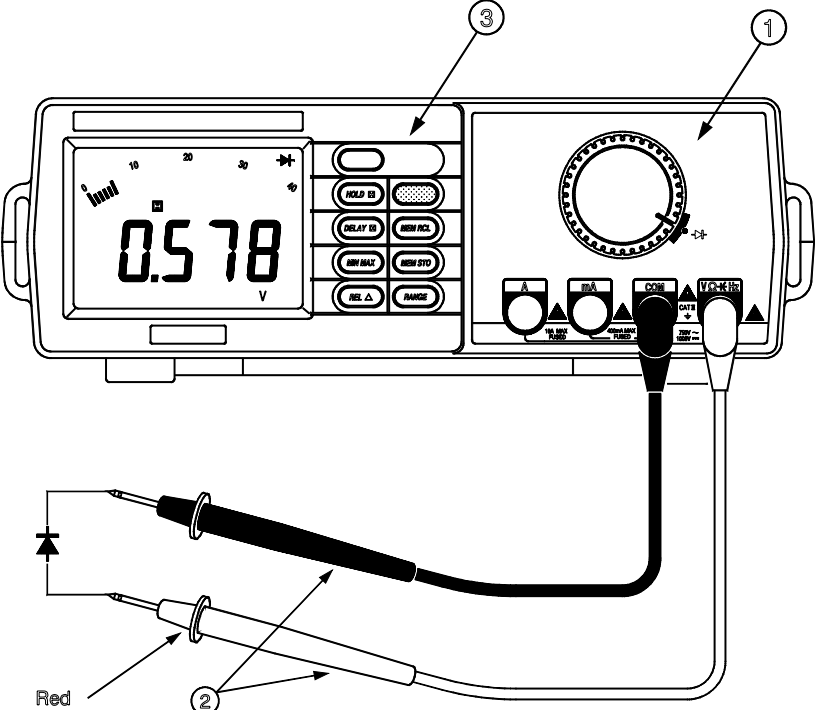





Figure 2-7. Diode Tests

⚠ WARNING

Measurements must only be made with the circuit power OFF.

- ①. Turn the Selector to Diode.
- ②. Connect the leads as shown: Insert the black and red test leads into the **COM** and **VΩ → Hz** input terminals respectively.
- ③  and  are not available in the Diode test; all other buttons can be used.

The diode Test is as follows:

1. Set the () position by turning the rotary switch.
1. Insert the black and red test leads into the **COM** and **VΩ → Hz** input terminals respectively.
2. The red lead should be connected to the anode and the black lead to the cathode of the diode.
3. The typical voltage drop should be about 0.6V for silicon diode or 0.3V for germanium diode.
4. If the diode is reverse biased or there is an open circuit the reading displayed will be between 3.000V and 3.400V.
5. The Diode test is always fixed the range

Measuring Resistance and Continuity

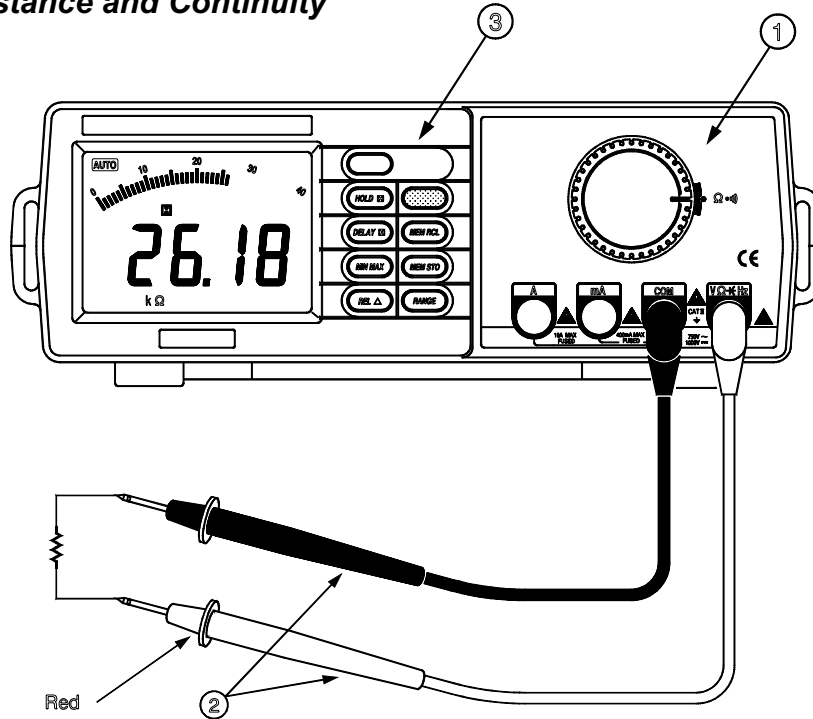





Figure 2-8. Resistance and Continuity Measurements

-
- ①. Turn the Selector to Resistance and Continuity Measurement.
 - ②. Connect the leads as shown.
 - ③.  is not available in the continuity test ; all other buttons can be used.

The Resistance or Continuity measurement is changed alternatively by each press the button 

The Resistance Measurement is as follows:

1. Select the Resistance Measurement by Pressing the 
2. Insert the black and red test leads into the **COM** and **VΩ → Hz** input terminals respectively.
3. Select the desired ohms (Ω) range or to set auto-range. Connect the black and red test probe tips to the circuit or device under test, making sure it is de-energized first.
4. Turn off any power to the resistor to be measured. Discharge any capacitor. Any voltage present during a resistance measurement will cause inaccurate readings and could damage the meter if exceeding the overload protection of 250V DC or AC rms.
5. Open circuits will be displayed as an overload condition and MSD (Most Signification Digit) blinks.
7. The resistance in the test leads can diminish accuracy on the lowest (400Ω) range. The error is usually 0.1 to 0.2Ω for a standard pair of test leads. To determine the error, short the test leads together and then use the  Relative mode to automatically subtract the lead resistance from resistance measurements.

7. After all measurements are completed, disconnect the test leads from the circuit and multimeter input terminals.

The Continuity () Measurement is as follows:

1. Select the Continuity Measurement by Pressing the button .
2. Insert the black and red test leads into the **COM** and **VΩ→Hz** input terminals respectively.
3. Connect the black and red test probe tips to the circuit or device under test, making sure it is de-energized first.
4. An audible tone will sound for resistance less than approximately 40 Ω.
5. After Continuity Measurement is completed, disconnect the test leads from the circuit and multimeter input terminals.
6. The Continuity Measurement is always fixed the range. Open circuit voltage approximately 0.45V.

Chapter 3

Specifications

General Specifications

Maximum voltage between terminals and earth ground: CAT. II 1000V DC or 750V AC RMS (Sine)

Display: 3 3/4 digit (4000 count) digital indication. Frequency Range: 9999 counts Max.

42 segment analog bar graph

Full annunciates, automatic polarity indication

Measuring rate: Digit 2 times per second

Analog bar graph 20 times second

Capacitance 1 time per second

Overrange indications: MSD (Most Signification Digit) Blinks

Low Battery Indication: The “” mark is displayed when the battery load voltage drops below accurate operating level.

Temperature Coefficient: $0.15 \times \text{Specified Accuracy per } ^\circ\text{C}$

$<18^\circ\text{C}$ or $>28^\circ\text{C}$

Temperature: Operating 5°C to 35°C

Storage -10°C to 60°C

Relative Humidity: 20% to 75% RH (5°C to 35°C)

Backlight: LED Lumination

Safety: Designed to IEC 1010-1 specifications

Power Requirements: AC 90V to 132V, 50/60 Hz, <10VA min or AC 198V to 264V, 50/60 Hz, <10VA min
(to buy by user optional)

NEDA 1604 6F22 006P type one piece or IEC LR6 AM3 AA 1.5V×6 piece.

Size: 238mm(W)×230mm(L)×83mm(H), without carrying strap

Weight: Approx. 1.5kg, without power cord

Accuracy is given as \pm (% of reading + number of least significant digits) at 18°C to 28°C, with relative humidity up to 75%.

All specifications assume less than 1 year since calibration.

Resolution and Accuracy

DC Volts (mV DC)

Range	resolution	Accuracy (% rdg + digits)
400mV	0.1mV	$\pm(0.3\% \text{ rdg} + 5\text{d})$
4V	1mV	$\pm(0.3\% \text{ rdg} + 2\text{d})$
40V	10mV	$\pm(0.3\% \text{ rdg} + 2\text{d})$
400V	100mV	$\pm(0.3\% \text{ rdg} + 2\text{d})$
1000V	1V	$\pm(0.3\% \text{ rdg} + 2\text{d})$

Input Impedance: 10M Ω , <100PF

Overload Protection: 1000V DC or 750V AC RMS

AC Volts (true rms, ac-coupled)

Range	resolution	Accuracy (% rdg + digits)
4V	1mV	$\pm(0.8\% \text{ rdg} + 5\text{d})$ 50Hz to 60Hz
40V	10mV	
400V	100mV	$\pm(1.2\% \text{ rdg} + 5\text{d})$ 45Hz to 1kHz
750V	1V	

Input Impedance: 10M Ω , <100PF

Overload Protection: 1000V DC or 750V AC RMS

AC coupled True RMS responding

DC Current

Range	resolution	Accuracy (% rdg + digits)
4mA	1 μ A	\pm (0.8% rdg + 5d)
40mA	10 μ A	\pm (0.8% rdg + 5d)
400mA	100 μ A	\pm (0.8% rdg + 5d)
10A (20A for 30 seconds)	10mA	\pm (1.5% rdg + 10d)

Input Protection: F500mA / 250V fuse for mA input; F15A / 250V fuse for A input

Burden voltage: 600mV max. for mA input; 900mV max. for A input

AC Current

Range	resolution	Accuracy (% rdg + digits)	
4mA	1 μ A	\pm (1.5% rdg + 5d)	45Hz to 400Hz
40mA	10 μ A	\pm (1.5% rdg + 5d)	45Hz to 400Hz
400mA	100 μ A	\pm (1.5% rdg + 5d)	45Hz to 400Hz
10A (20A for 30 seconds)	10mA	\pm (2% rdg + 10d)	45Hz to 400Hz

Input Protection: F500mA / 250V fuse for mA input; F15A / 250V fuse for A input

Burden voltage: 600mV max. for mA input; 900mV max. for A input

AC coupled True RMS responding

Resistance

Range	resolution	Accuracy (% rdg + digits)
400 Ω	0.1 Ω	\pm (0.5% rdg + 5d)
4k Ω	1 Ω	\pm (0.5% rdg + 3d)
40k Ω	10 Ω	\pm (0.5% rdg + 3d)
400k Ω	100 Ω	\pm (0.5% rdg + 3d)
4M Ω	1 k Ω	\pm (1% rdg + 5d)
40M Ω	10k Ω	\pm (1.5% rdg + 10d)

Open circuit Voltage: 0.45V

Input protection: 250V RMS

Continuity Test

Continuity threshold: Approx. 40 Ω

Continuity threshold: 2kHz tone buzzer

Input protection: 250V RMS

Diode Test

Test current: 0.6mA

Open circuit voltage: Approx. 3.0V

Input protection: 250V RMS

Capacitance

Range	resolution	Accuracy (% rdg + digits)	
4nF	1pF	$\pm (2\% \text{ rdg} + 40\text{d})$	in relative mode
40nF	10pF	$\pm (2\% \text{ rdg} + 5\text{d})$	in relative mode
400nF	100pF	$\pm (2\% \text{ rdg} + 5\text{d})$	in relative mode
4 μ F	1nF	$\pm (2\% \text{ rdg} + 5\text{d})$	
40 μ F	10nF	$\pm (2\% \text{ rdg} + 5\text{d})$	at $\leq 20 \mu$ F
		$\pm (5\% \text{ rdg} + 5\text{d})$	at $> 20 \mu$ F

Input protection: 250V RMS

Frequency Counter

Ranges: 100Hz, 1kHz, 10kHz, 100k Hz, 600kHz Resolution: 0.01Hz in the 100Hz range

Accuracy: $\pm (0.1\% + 4\text{d})$

Sensitivity: 100mV rms for 1Hz to 20kHz, 500mV rms for 20kHz to 600kHz

Input protection: 250V RMS

Adapted Range

Display: 10 counts per 1mV DC

Accuracy: $\pm (0.3\% + 5\text{d})$

Input protection: 250V RMS

Chapter 4

Maintenance

Introduction

Repairs or servicing not covered in this manual should only be performed by qualified personnel.

Replacing the Battery

 **WARNING**

To avoid electrical shock, Disconnect power leads from live power source, and the test leads and any input signals before replacing the battery. Replace only with same type of battery.

When the multimeter displays the "  "mark, the battery must be replaced to maintain proper operation. Use the following procedure to replacing the battery:

1. Disconnect test leads from any live source, turn the rotary switch to off, and remove the test leads from the input terminals.

-
2. Remove screws on the battery cover and open the case.
 3. Remove the exhausted battery and replace with a new equivalent 9 voltge battery.
 4. Two types of batteries are used in the bench multimeter: one of is a NEDA 1604 6F22 006P type one piece or equivalent 9 voltge battery; other of is IEC LR6 AM3 AA 1.5V×6 piece.
 5. Never use the bench multimeter unless the battery cover is in place and fastened fully.

Replacing the Fuse

WARNING

To avoid electrical shock, disconnect the test leads and any input signals before replacing the fuses. Replace only with same type of fuses. The A input terminal is protected by a F15A/250V fast blow ceramic fuse. The mA input terminal is protected by a F500mA/250V fast blow fuse.

Use the following procedure to examine or replace the multimeter of fuses:

1. Turn the power switch to off, and remove the power cable from live power source.
2. Disconnect test leads from any live source, turn the rotary switch to off, and remove the test leads from the input terminals.
3. Open the tools cover on the top cover, and open the fuse cover in the tool case.

-
4. Remove the blown fuse. replace with fuse of the same size and rating. Make sure the new fuse is centered in the fuse holder.
 5. Replace the blown fuse with same ratings.
 6. The **A** input terminal is protected by a F20A/250V fast blow ceramic fuse, $\Phi 6 \times 32\text{mm}$. The **mA** input terminal is protected by a F500mA/250V fast blow fuse, $\Phi 5 \times 20\text{mm}$.
 7. Fuse rarely need replacement and blow almost always as a result of the operator's error.
 8. Never use the bench multimeter unless the fuse cover is in place and fastened fully.

Replacing the Power Fuse

WARNING

To avoid electrical shock, Disconnect power cable from live power source before replacing the power fuse, and the test leads and any input signals before replacing the power fuses. Replace only with same type of fuses.

Use the following procedure to examine or replace the power fuses:

1. Turn the power switch to off, and remove the power cable from live power source.
2. Disconnect test leads from any live source, turn the rotary switch to off, and remove the test leads from the input terminals.

3. Replace the power fuse from the supply power In let with fuse. Replace the blown fuse with same ratings.
4. The power fuse: 100mA / 250V, Fast, $\Phi 5 \times 20$ mm.

Other Note

1. Do not use abrasives or solvents on the bench multimeter, use a damp cloth mild detergent only.
2. If any faults or abnormalities are observed, the bench instrument can not be used any more and it has to be checked out.