



Table of Contents

1 Warning - Read this first	5
2 Introduction	6
3 Product overview	7
1 VPFlowScope M transmitter.....	7
2 VPSensorCartridge	8
3 Safety system	9
4 Configuration	9
4 Quick start	10
5 Measurement	12
1 Flow	12
2 Pressure	12
3 Temperature	12
4 Totalizer	13
6 Mechanical installation	14
1 Installation point	14
2 Piping table	16
3 Safety system	17
4 Assembling and installing the instrument.....	18
5 Replacing the VPSensorCartridge.....	20
7 Connectivity & communication	23
1 LEDS	23
2 4..20mA output	23
3 Pulse output	24
4 RS485	25
5 USB	25
6 Ethernet	25
7 Wi-Fi	26
8 Internal web server	28
9 Modbus TCP	28
10 Display	29
Display	29
Display status icons	29
Custom units	30
Keypad	30
Menu	30

11 Data logger	34
Cyclic mode	34
Multi session mode	34
8 Alarm	35
9 Modbus	36
10 Electrical connections	40
1 4..20mA	40
2 Pulse	41
3 Alarm	42
4 RS485	42
5 Ethernet	44
11 VPStudio software	45
12 Exchanging VPSensorCartridges	46
13 Specifications transmitters	47
14 Specifications VPSensorCartridges	48
15 Order information and accessories	49
1 Transmitter	49
2 VPSensorCartridge	49
3 Accessories	49
16 Appendix A - Underwriters Laboratories (UL)	50
17 Appendix B - Federal Communications Commission (FCC) Statement	51

1 Warning - Read this first

	<p>Compressed air can be dangerous! Please familiarize yourself with the forces under pressurized conditions. Respect the local guidelines and regulations for working with pressurized equipment.</p>
	<p>Gas flow through pipes follows certain physical laws. These physical laws have serious consequences for the installation requirements. Familiarize yourself with the basic physical laws of flow measurement, to make sure that the product is installed correctly. Always make sure that upstream length, downstream length, flow, pressure, temperature and humidity conditions are within specifications.</p>
	<p>Precision instruments need maintenance. Check your flow meter regularly and make sure it remains clean. When polluted, gently clean the sensor using de-mineralised water or cleaning alcohol.</p>
	<p>Not intended for fiscal metering or billing. Our flow meters are not certified for fiscal metering. Laws on fiscal metering and billing may vary per country or state.</p>
	<p>Do not overestimate the results. VPIstruments does not take any responsibility for the correctness of measurement results under field conditions. The practical measurement uncertainty of a flow meter in the field may vary, depending on how well it is installed, due to the nature of gas flow. The piping table provides guidelines on how to optimize the field accuracy. Our products are not intended to be used as a single means to determine compressor capacity.</p>
	<p>Do not open the device. Our instruments are assembled with high precision. Opening this device is dangerous and may destroy the instrument. Warranty is voided when you open the instrument.</p>
	<p>Feedback leads to product improvement. Please share your experience with us, as we are continuously improving our products in our commitment to quality, reliability and ease of use. Let us know</p>

2 Introduction

Congratulations! **You purchased the easiest to use and most complete compressed air measurement tool in the world.** With the VPFlowScope M, you can monitor flow, pressure, temperature, and total air consumption, simultaneously. The optional data logger enables you to record all 4 parameters.

With the introduction of the VPFlowScope M, re-calibration becomes history. Unlike traditional flow meters, the VPFlowScope M does not require traditional re-calibration. Instead, the VPFlowScope M consists of a transmitter in combination with the patented VPSensorCartridge which reduces re-calibration to a simple exchange.

But there is more to the VPFlowScope M:

- Three in one: flow, pressure and temperature simultaneously
- Wide measurement range (1:300)
- 2% reading accuracy on flow
- Ultra compact size and low weight
- Optional direction measurement
- Optional display
- Optional data logger
- Optional Wi-Fi

Great products deserve great user manuals. We have done our best to make this user manual as complete as possible. New users, please read it carefully to familiarize yourself with our products. Experienced users can check out

Check the packaging box for any inconsistencies. Should there be any shipping damage, notify the local carrier. At the same time a report should be submitted to Van Putten Instruments BV, Buitenwatersloot 335, 2614 GS DELFT, The Netherlands.

This manual is dedicated to:

VPFlowScope M transmitter: VPM.T001.DXXX

VPFlowScope M VPSensorCartridge: VPM.R150.P35X.PN10

VPStudio software version 2.1.0

Transmitter firmware version 1.2.3

VPSensorCartridge firmware version 1.0.1

3 Product overview

3.1 VPFlowScope M transmitter

Meet the transmitter, the 'brains' of the VPFlowScope M. The transmitter is one part of the VPFlowScope M which needs to be combined with a VPSensorCartridge and a safety system. The transmitter features various outputs. Modbus, 4..20 mA, pulse, USB, Ethernet, alarm are all standard. The optional display and data logger offer additional functionality for visualisation and data logging. The Wi-Fi option adds an additional connectivity option to your transmitter.

The transmitter is available in 4 configurations to fit every application. The available models are listed in the table below. The transmitter is to be used with the VPSensorCartridge. There are two VPSensorCartridges available, both having their own unique features. Inside the VPSensorCartridge are sensors that perform the actual measurement.

When mated to a VPSensorCartridge, the transmitter can be rotated 360 degree. This enables you to align the display for every orientation. Turn the locking ring loose when rotating the display.

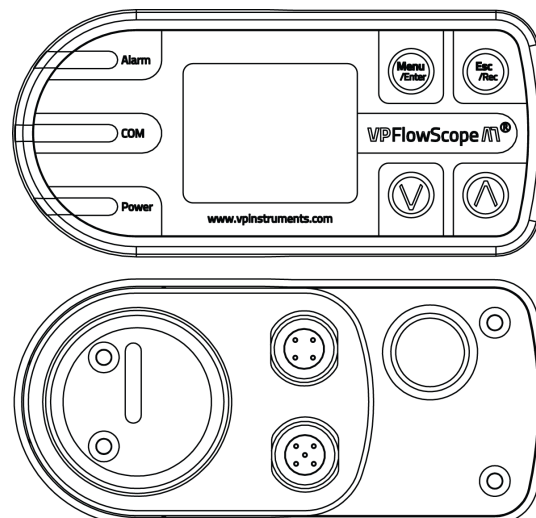

Available transmitter models

Order Code	4..20 mA/ Pulse/ Alarm	RS485	USB	Ethernet	Display	Data logger	Wi-Fi
VPM.T001.D000	√	√	√	√			
VPM.T001.D010	√	√	√	√	√		
VPM.T001.D011	√	√	√	√	√	√	
VPM.T001.D111	√	√	√	√	√	√	√

Available models on day of printing

3.2 VPSensorCartridge

The VPSensorCartridge includes all sensors to measure flow, pressure and temperature simultaneously. It also includes the calibration characteristics for all available sensors. This makes it possible to exchange the VPSensorCartridge between transmitters or to replace it when calibration is required.

All VPSensorCartridges use a proprietary interface. Therefore every type of VPSensorCartridge can be connected to every model of transmitter. [See chapter 3.1](#) for all available transmitters.

The VPSensorCartridge has a flow direction indicator in the shape of an arrow that points in the positive direction. The indicator can be used for proper alignment.

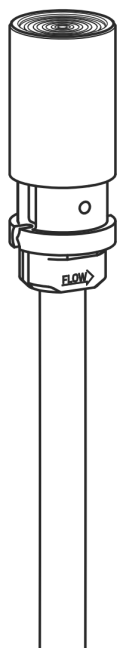

Available VPSensorCartridge models

Order Code	Flow	Temperature	Pressure	Bi-directional
VPM.R150.P350.PN10	√	√	√	
VPM.R150.P351.PN10	√	√	√	√

Available models on day of printing

3.3 Safety system



Installation under pressure can be dangerous. Make sure that you understand the safety system before installing the VPFlowScope M.

The safety system is specially designed for the VPFlowScope M. When the VPSensorCartridge is in the compression fitting and the safety cable is attached with the locking ring fully tightened, the probe can never exit the compression fitting due to the matching length of the cable. When the VPSensorCartridge is installed on the right depth, the safety cable can be strained and locked. The complete safety system is tested and certified for safety. Instructions on how to assemble the safety system can be found in [chapter 6 mechanical installation](#).

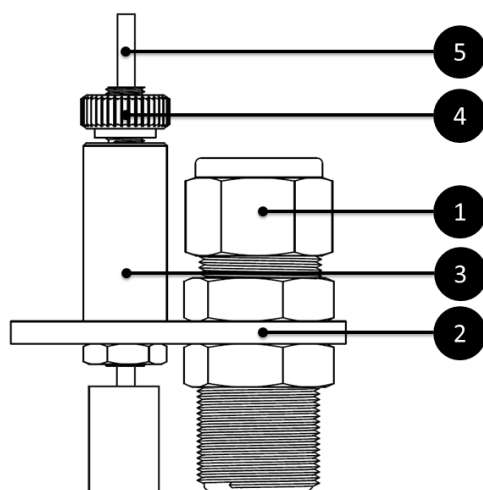

1. **Compression fitting:** 0.5 inch with Teflon ferrule
2. **Safety plate:** Used to connect fitting and safety system
3. **Auto brake:** The safety chain can be slide through the auto brake system. Moving upwards is only possible when the safety lock is pushed downwards
4. **Safety lock:** This nut can be used to lock or unlock the safety release. Push down the lock to release the safety chain
5. **Safety chain:** The safety chain can be attached to the VPSensorCartridge

3.4 Configuration

The VPFlowScope M needs only one step to be ready for basic operation. It needs to know the exact inner pipe diameter for accurate measurement, wrong inner diameter will lead to very significant misreadings. The pipe diameter can be programmed with the keypad on the display module, via the built-in Web interface or with the VPStudio configuration software. This software suite is also used for configuration of the outputs and data logger. This software can be downloaded from our website. www.vpinstruments.com/downloads. The exact inner diameter can be measured using a wall thickness gauge, ask us for availability.

The default units are set to SI. For read out in Imperial units, use the keypad to change the units via the menu. Go to menu->settings->display->rows.

4 Quick start

This chapter contains the basic steps to start using your VPFlowScope M. Additional information on all subjects can be found in the next chapters.

1. Unpack

Unpack the box and check if all items are there and in good shape.

2. Apply power

Connect the unit to a DC power source (12..24 VDC). See [chapter 7 electrical connections](#).

3. Mechanical installation

- Find the best point of installation for this product. Make sure that the process conditions are within the specifications of the flow meter and the upstream and downstream straight pipe lengths are respected
 - For installation of the VPFlowScope M, an insertion point needs to be created. A socket with internal 1/2 inch thread is required
 - A ball valve with a minimum size of 0,5 inch female BSP or NPT process connection should be in place
 - Assemble the VPFlowScope M including safety system and mount it on top of the ball valve
 - Open the valve and insert the probe
 - The sensor needs to be in the middle of the pipe for diameters larger than 2 inch. [See chapter 6.1 installation point](#)
 - Tighten the compression fitting according to instruction
 - Pull on the safety chain to strain it and turn the safety lock clockwise to lock it
- [See chapter 6 mechanical installation](#) for more detailed information

4. Electrical installation

4.1 Permanent installation

Connect a cable with 5 Pin M12 connector to the transmitter. The cable can be connected to VPVision, a central data acquisition / building management system or data logger via Modbus RTU (TCP), 4..20mA or pulse. Connect the 4 Pin M12 connector to the transmitter and the other side to a laptop or router for an Ethernet connection.

Apply 12..24 VDC to power up the device. Use a Class II power supply (less than 2 Amps). If a display is present, it will light up when power is applied.

4.2 Temporary installation

Use a 24 Volt power supply with M12 connector to power the device.

[See chapter 10 electrical connections](#) for more information.

5. Configure the transmitter

For correct measurement, the diameter should be programmed into the instrument.

- The quickest way: Program the inner pipe diameter via the display. Go to menu->settings->diameter
- Alternative method: The diameter can also be programmed through an Ethernet or Wi-Fi connection using the internal web server and direct USB connection to the transmitter using the VPStudio software
- Advanced settings: Use the built in web server or VPStudio to set the output parameters for networking, Modbus, pulse, alarm and current outputs

6. Data recording

When the transmitter has an integrated data logger, a data log session can be started pressing the record button. The data logger uses 5 second intervals for all measurement parameters by default. The data logger can also be put in cyclic mode where it will always record data using 1 second intervals for all parameters. Changing the mode and intervals can be done using the display or with the VPStudio software.

5 Measurement

For all parameters the update interval is 1 second. Within this second, multiple samples are taken and averaged to provide a stable and reliable output.

5.1 Flow

The VPSensorCartridge uses our proprietary insertion type thermal mass flow sensor. There is no bypass flow, which results in a high robustness and less sensitivity for dirt or particles. The flow sensor is directly temperature compensated. The flow reading is under normalized conditions (DIN 1343).

The sensor response signal is directly related to the mass flow rate and can be described by the following formula:

$$V_{out} = k \cdot \lambda \cdot \rho \cdot v \cdot (T_s - T_g)$$

V_{out} = output voltage

k = sensor (geometrical) constant

λ = thermal conductivity of the gas

ρ = density of the gas

v = actual velocity in m / sec

T_s = sensor temperature

T_g = gas temperature

The optional bi-directional sensitivity is shown in the picture on the right. In bi-directional mode the negative flow value will show up as a minus sign.

No flow
Everything in balance.

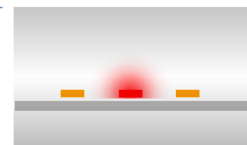

Flow from left
The left part is cooled down; the right part of the bridge is heated up.

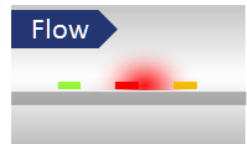

Flow from right
Vice versa! Now the left part is heated up and the right part is cooled down.

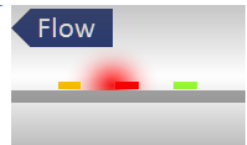

5.2 Pressure

The VPSensorCartridge features a built-in gauge pressure sensor. Check specifications for details. The sensor membrane can handle media which are compatible with glass, silicon, stainless steel, Sn/Ni, plating and An/Ag solder.

5.3 Temperature

The built in temperature sensor measures the compressed air / gas temperature. At low flow rates between zero flow and 10 m_n/sec, the temperature sensor may heat up itself due to the heated flow sensor element. This will result in higher read out for temperature.

Temperature compensation effects: The flow sensor is compensated dynamically for changes in gas temperature. When exposed to quick temperature changes or large temperature changes (for example taking the unit from outdoor to indoor during winter time, or when mounted downstream of a heat regenerated drier) the temperature compensation may lag behind, which may result in significant measurement errors.

5.4 Totalizer

The totalizer keeps track of the total consumed amount of compressed air in normal cubic meters, normal liters per minute or in (M)(M)SCF depending on which unit you choose to read out. The refresh interval is 1 second: Actual totalizer data will be available on the display and via the Modbus interface. The totalizer value is written to it's internal memory with an interval of 15 minutes. A power failure may result in maximum 15 minutes of totalizer data loss.

The transmitter features 2 totalizers, plus a combined totalizer. The first totalizer counter will count up all positive flow, the second counter will count up all negative flow. The sum of these two totalizer values is shown on the display and can also be read out via Modbus. The display will show totalizer values up to 99.999.999,9 and will then become 0,0 independent of the taken unit. The totalizer will not be cleared and higher values will be available via Modbus and VPStudio. Via Modbus, all three totalizers are available. [See chapter 9](#) for Modbus registers.

The totalizers can only be reset to zero, and will be reset all together. It's not possible to set them to any different value.

6 Mechanical installation

6.1 Installation point

The installation point is crucial for a correct measurement. Sources of error can be: installation effects, unknown flow profiles, swirls, pressure and temperature effects, humidity effects, oscillations in the flow, etc. To ensure the highest possible accuracy of flow measurement, the installation and piping instructions must be followed. Therefore read this paragraph carefully.

Take into account:

- Choose a location which is accessible, which allows access for wiring and maintenance activities
- Meet the specifications of the VPFlowScope M. When the specifications are not met, for instance the pressure or temperature level is too high; this will cause inaccurate flow measurement and can even damage your flow meter
- Do not apply mechanical stress on the VPFlowScope M

Avoid:

- Excessive heat, check the temperature specifications
- Corrosive atmosphere where possible
- Electrical problems (high voltage/ high power)
- Mechanical vibration and danger (walking bridges, fork lift trucks)
- Any environmental source of potential error



Stop: These devices are for use with Air, Nitrogen, Argon, Helium, Carbon Dioxide and other non hazardous and non-corrosive gases

Prepare the installation

The VPFlowScope M can be inserted through a tap with 1/2 inch female thread. For installation under pressurized conditions a VPInstruments hot tap saddle can be used.

Use a 1/2" full bore ball valve to insert and retract the VPFlowScope M when you want.



Warning: Make sure that the hole is at least 16 mm | 0.63 inch, and completely clear for insertion. A too small hole will damage the probe or can block the probe when entering the pipe.

Installation procedure

Insertion depth

Generally the insertion depth of the VPFlowScope M is 0.5 times the inner pipe diameter, where the bottom of the sensor tip must be in the middle of the pipe (see picture).

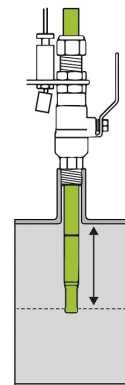

Position

Install the VPFlowScope M upwards in an angle between 1 and 2 o'clock (see picture). Never install the instruments upside down.

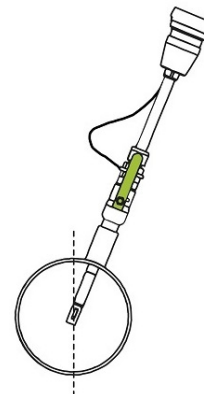

The VPSensorCartridge has a flow direction indicator, this also indicates the alignment of the instrument. A second indicator can be found on the safety system. Make sure it points in the right flow direction. Alignment "by the eye" is sufficient.



Info: A ruler can be used to align the instrument. It can be placed on the flat area where the direction indicator is located.

Exception

Between pipe sizes of 1" and 2": be aware that the field accuracy is +/- 10%; installation errors are bigger. The insertion depth between DN25 and DN65 is also different. The VPFlowScope M probe has to be inserted almost completely to the bottom of the pipe or else the temperature sensor of the VPFlowScope M probe itself is outside the flow path. The sensor tip will not be in the middle of the pipe any more. The measurement value is automatically corrected for small diameters.

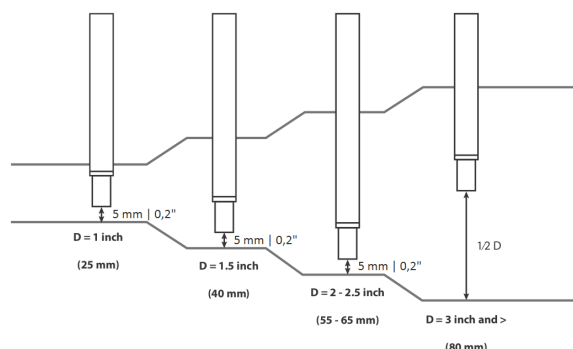

6.2 Piping table

Check the piping table below for your application. The table shows the amount of length upstream or downstream depending on the installation. If applicable in front of the meter, use given upstream length. If applicable in behind the meter, use given downstream length. Gas flow in pipes follows certain rules, which must be observed for optimal measurement results. For some exceptions the upstream length needs to be longer, or can be shorter.



If possible, you can always choose a longer upstream length, as these are minimum values. The up- and downstream lengths are used industry wide as guidelines, but will never be a guarantee for obtaining the "true value".

Piping table

The following table provides a guideline for proper distances between upstream or downstream objects and the VPFlowScope M. The upstream length is the length between the last non-straight object and the VPFlowScope M. If the upstream length is straight, and the distortion is downstream of the VPFlowScope M, you can use the column "downstream length" as a guideline. In very complex situations, with multiple up- and downstream objects, you should consider another location. This table is a practical guideline and is not exact science. Practical situations can have multiple sources of distortion, therefore VPInstruments does not take any responsibility for the correctness.

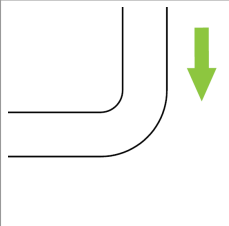
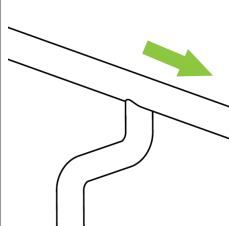
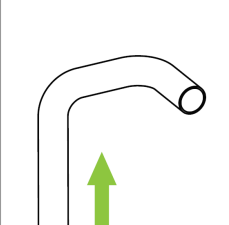
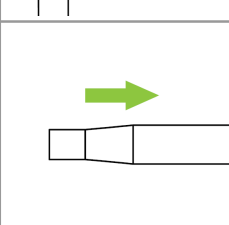
Picture	Description	Upstream length ²	Downstream length ²	Effect
	Single elbow	$30 * D^1$	$10 * D^1$	Distorted flow profile
	Complex feed-in situation (header)	$40 * D^1$	$10 * D^1$	Flow profile will be distorted
	Double elbow, multiple elbows following each other	$40 * D^1$	$10 * D^1$	Distorted profile + swirl
	Diameter change from small to large (gradual or instant)	$40 * D^1$	$5 * D^1$	Jet shaped flow

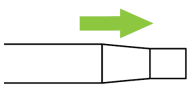
	<p>Diameter change from large to small (gradual change, between 7 and 15 degrees)</p>	<p>$10 * D^1$</p>	<p>$5 * D^1$</p>	<p>Flattened flow profile</p>
---	---	------------------------------	-----------------------------	-------------------------------

1 = inner diameter; 2 = minimum length

6.3 Safety system

See chapter 3.3 safety system, for all safety system parts.

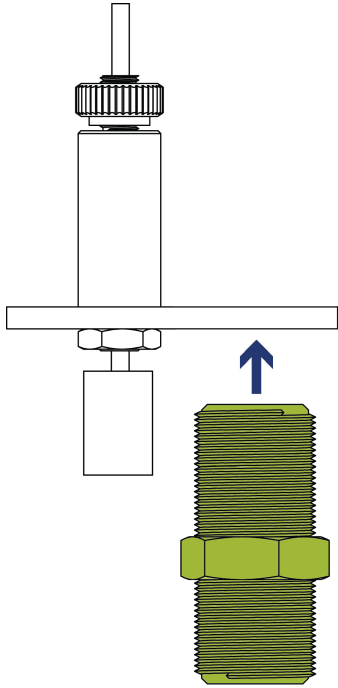
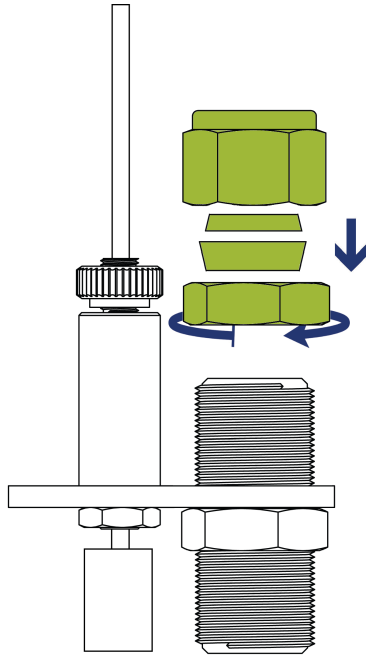
	
<p>Step 1.</p> <ol style="list-style-type: none"> 1. Remove the compression fitting's parts on the long threaded end side 2. Place the safety plate over the compression fitting long threaded end 	<p>Step 2.</p> <ol style="list-style-type: none"> 1. Mount the nut, and close tight. Then mount the compression fitting's teflon rings and nut

6.4 Assembling and installing the instrument

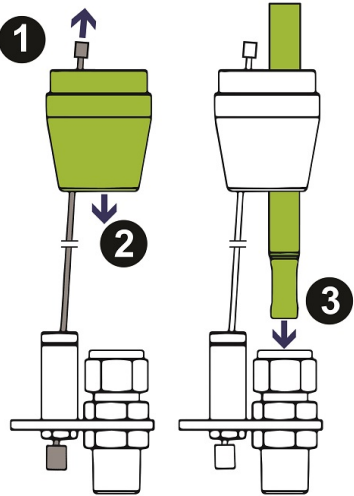
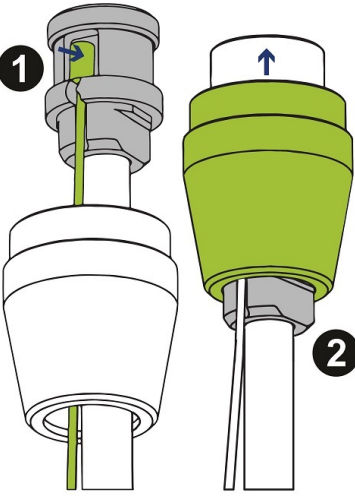
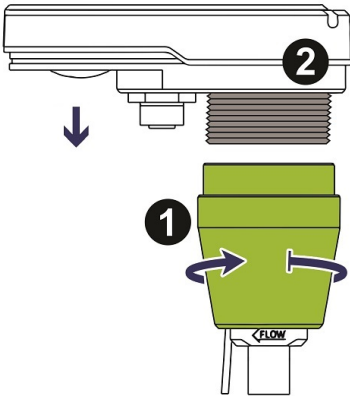
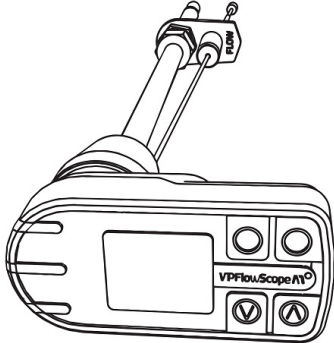
	
<p>Step 1</p> <ol style="list-style-type: none"> 1. Lift the safety cable 2. Slide the locking ring over the safety cable 3. Place the VPSensorCartridge through the locking ring into the compression fitting 	<p>Step 2</p> <ol style="list-style-type: none"> 1. Mount the safety line to the VPSensorCartridge, it should snap in completely 2. Move the locking ring upwards over the VPSensorCartridge and hold it in place
	
<p>Step 3</p> <ol style="list-style-type: none"> 1. Place the transmitter on top of the assembly 2. Align the probe with the display (default position, arrow should point to the left as on the picture). Tighten the locking ring completely 	<p>Step 4</p> <p>The assembly should look like this. Check if the safety line is secured</p>

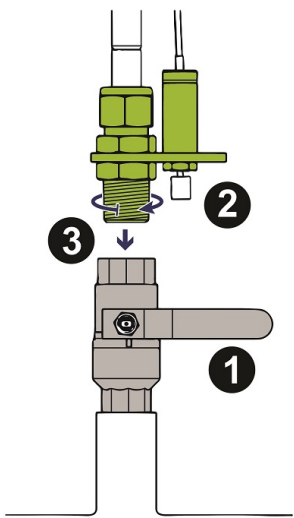
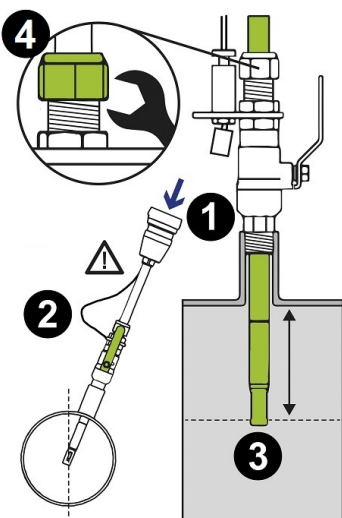
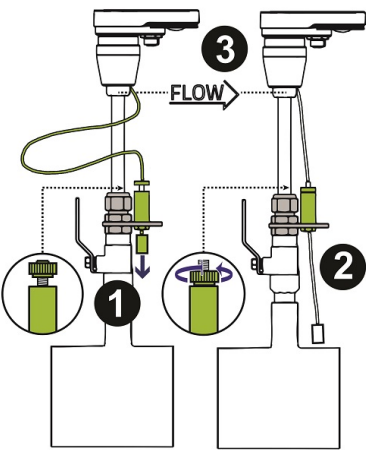
	
<p>Step 5</p> <ol style="list-style-type: none"> 1. Keep the ball valve closed, the probe remains in the compression fitting 2. Check if the safety system is locked 3. Mount the VPFlowScope M including safety system on the ball valve 	<p>Step 6</p> <ol style="list-style-type: none"> 1. Keep your hand on top of the transmitter ⚠ When you install the VPFlowScope M assembly into a pressurized system you are about to experience temporary leakage and force trying to push out the VPFlowScope M probe from the compression fitting. When the safety system is correctly installed this is part of the normal installation procedure. 2. Open the ball valve slowly and push the VPFlowScope M probe gently downwards. 3. The probe tip should be in the centre of the pipe 4. Tighten the compression fitting
	
<p>Step 7</p> <ol style="list-style-type: none"> 1. Unscrew the safety lock and pull the safety line tight 2. Tighten the safety lock 3. Align the flow direction. Alignment by the eye is sufficient 	

6.5 Replacing the VPSensorCartridge

When a VPSensorCartridge needs to be replaced, there is no need to remove the complete assembly. The safety system can be left in place.

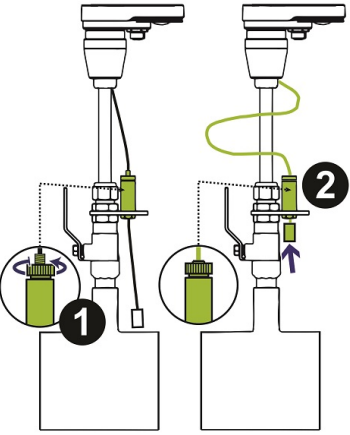
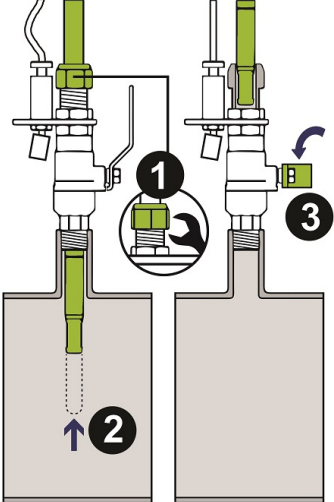
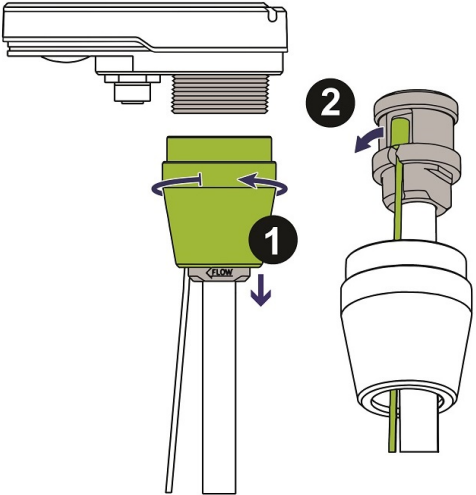
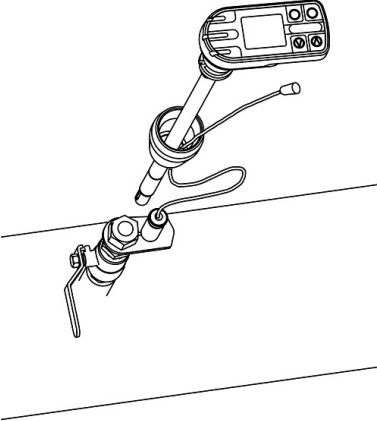
	
<p>Step 1</p> <ol style="list-style-type: none"> 1. Unscrew the safety lock 2. Push the safety lock downwards and lift the safety line until it reaches the end stop 	<p>Step 2</p> <ol style="list-style-type: none"> 1. Apply pressure by hand on top of the transmitter to prevent the VPFlowScope M to pop upward uncontrolled. Then slowly loosen the compression fitting 2. Lift the probe gently, until the safety chain is completely strained 3. Close the ball valve
	
<p>Step 3</p> <ol style="list-style-type: none"> 1. Unscrew the locking ring and slide it downwards 2. Put the transmitter aside 3. Remove the safety cable from the VPSensorCartridge 	<p>Step 4</p> <ol style="list-style-type: none"> 1. Replace the VPSensorCartridge

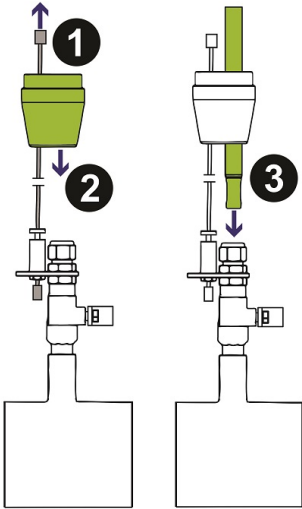
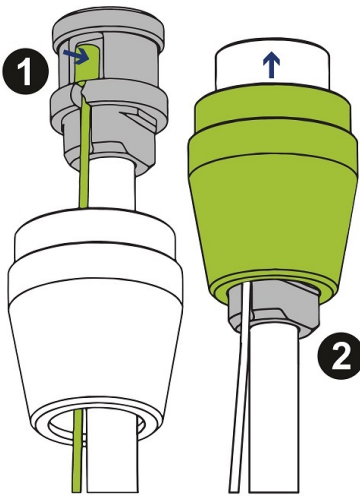
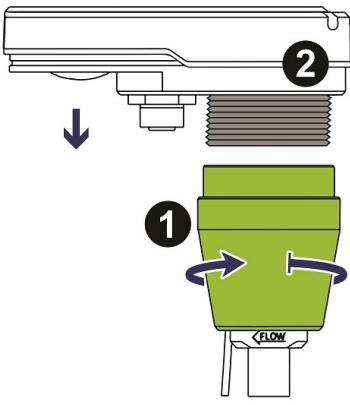
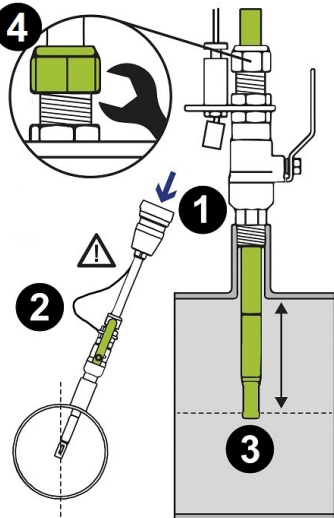
	
<p>Step 5</p> <ol style="list-style-type: none"> 1. Place the new VPSensorCartridge through the locking ring into the compression fitting 	<p>Step 6</p> <ol style="list-style-type: none"> 1. Mount the safety line to the VPSensorCartridge 2. Move the locking ring upwards over the VPSensorCartridge
	
<p>Step 7</p> <ol style="list-style-type: none"> 1. Place the transmitter on top of the assembly 2. Align the transmitter in the preferred position 3. Tighten the locking ring completely 	<p>Step 8</p> <ol style="list-style-type: none"> 1. Keep your hand on top of the transmitter ⚠ When you install the VPFlowScope M assembly into a pressurized system you are about to experience temporary leakage and force trying to push out the VPFlowScope M probe from the compression fitting. When the safety system is correctly installed this is part of the normal installation procedure. 2. Open the ball valve slowly and push the VPFlowScope M probe gently downwards. 3. The probe tip should be in the centre of the pipe 4. Tighten the compression fitting

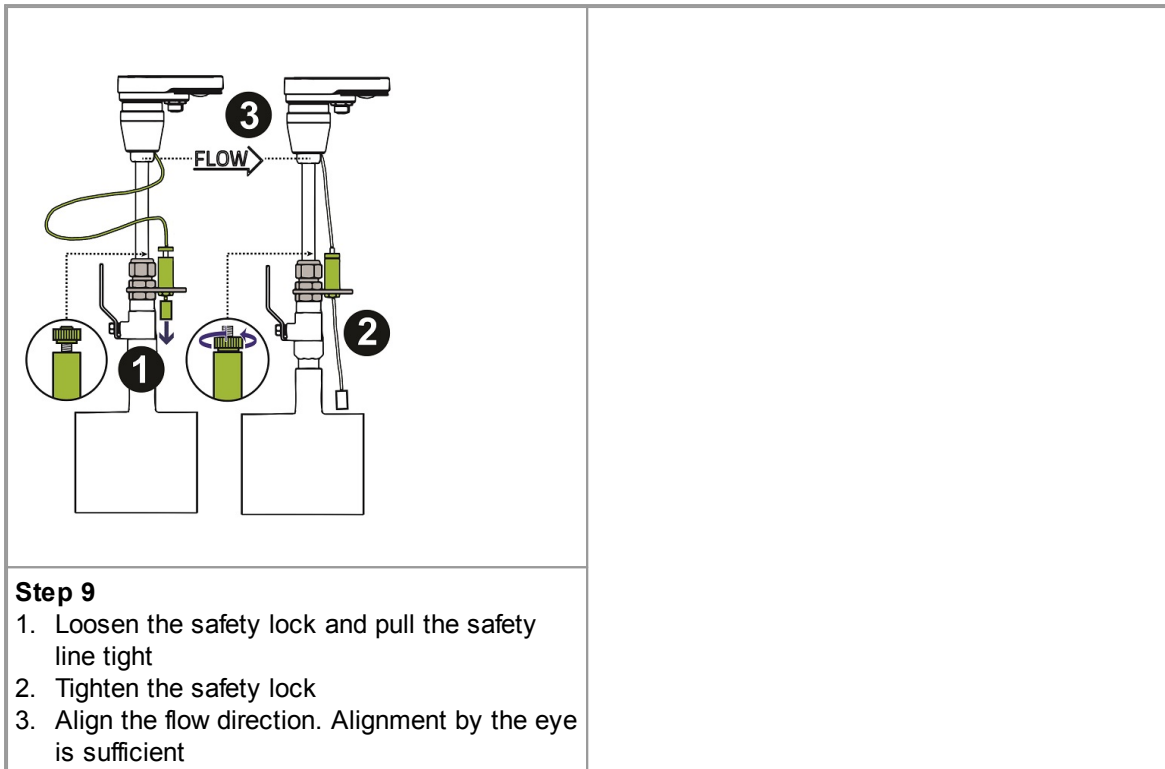

7 Connectivity & communication

The transmitter features various outputs which makes it possible to connect to VPVision, a central data acquisition / building management system. This chapter provides information on all options available. Check the product label to see which options are available on your transmitter.

7.1 LEDES

There are 3 LED's available on the transmitter that indicates the status of the instrument. Various colors and patterns are available.

Color	Patterns	Descriptions
Green	Blinking at 2 seconds interval	The transmitter is searching for a VPSensorCartridge
Green	On	VPSensorCartridge detected and ready for operation
Orange	Blinking fast	RS485 or USB communication
Red	On	Active alarm
Red	Blinking at 1 seconds interval	Error in VPSensorCartridge, read error code via display or Modbus
Red	Blinking once	Error in RS485 or USB communication

In case of an error code, contact your local distributor.

7.2 4..20mA output

The 4..20mA output can be used to connect the transmitter to VPVision, a central data acquisition / building management system, a multi-meter or any 4..20 mA based system. The 4..20 mA output an active current loop.

There is one 4..20 mA output available on the transmitter. This output can be assigned to one of the measurement parameters, only one can be selected. For each measurand, a number of units is available. The factory default is m_n/sec .

Measurand	Unit
Velocity	m_n/sec
Velocity	sfps
Flow	m_n^3/hr
Flow	m_n^3/min
Flow	m_n^3/sec
Flow	l_n/min
Flow	l_n/sec
Flow	SCFM
Pressure	bar (g)
Pressure	psi (g)
Temperature	°C

Temperature	°F
Temperature	K

All flow & velocity units are under normalized conditions (DIN 1343)

For scaling purposes, the zero and span matching 4 and 20mA can be modified using VPStudio, the built in web server or the key pads when available (Go to menu->settings->Analogue output->4..20mA settings) This will not affect the original measurement range. The 4mA is representing the lowest end of the range and 20mA the highest. The range can be adjusted to increase or narrow the resolution. For bi-directional measurement, the zero value needs to be set to a negative number which will result in 12mA for zero flow.

Configuration with VPStudio

With VPStudio, in the pull down menu, you can choose above units to assign to the output. Adjust the zero and span for scaling.

Changing to volumetric units, the programmed diameter is calculated in the settings. So change the diameter first, then the analogue settings. VPStudio provides feedback while you are changing the settings. Use "set default" to go back to the factory default.

4..20mA output

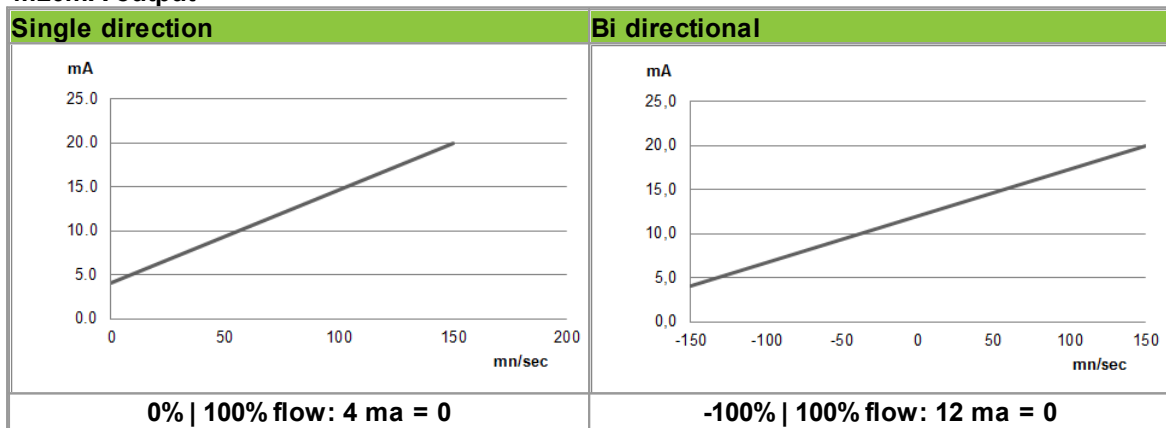

7.3 Pulse output

The transmitter features a low-frequency active pulse output. The pulse is a 'non potential' free output as it acts like a active current loop. To make it passive, an external third party isolator can be used.

The pulse interval can be set with the VPStudio software. This enables you to choose the amount of flow per pulse. A pulse from 0..20 mA will be generated when the interval exceeds. The maximum pulse frequency is once per 2 seconds. If the flow is higher then the configured pulse interval, pulses are stored in a queue and will be output when flow decreases.

The pulse output is connected to the internal (combined) totalizer value. When the totalizer has increased by the programmed pulse interval, the pulse will be generated. As it is not possible to generate a negative pulse, negative flow can not be indicated by pulse. In case of negative flow, the internal totalizer will count backwards. Pulses will not be generated until the same amount of positive flow has been added to the totalizer again. In this way we ensure that the pulse output will always be synchronized with the internal totalizer of the transmitter.

Pulse output

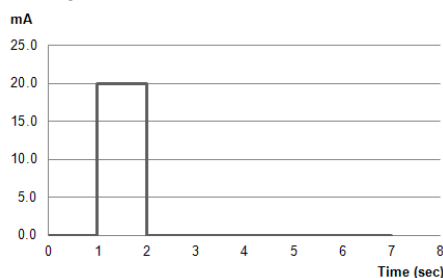

7.4 RS485

RS485 is a serial interface that can be used to connect the transmitter to VPVision, remote monitoring software or a building management system. The interface is standardised interface according to standard ANSI/TIA/EIA-485-A-98.

It is important to match the communication parameters. All devices using this serial interface need to communicate using the same settings. Various settings are available to match any building management system.

Communication settings

The RS485 communication settings can be changed with VPStudio. Below shows the available options

- Baud rate: 9600 | 19200 | 38400 | 57600
- Stop bits: 1 | 2
- Parity: None | Even | Odd

Factory default is: 38400, 1, none

The communication protocol is **Modbus RTU**. The Modbus table is identical to the Modbus TCP interface. More information can be found in the [Modbus chapter 9](#).

7.5 USB

The USB interface can be used to connect the transmitter to your computer. With the VPStudio software you are able to configure the device, or to read out recorded data. See the [VPStudio chapter 11](#) for more information.

The mini USB connector can be found on the bottom side of the transmitter. Remove the nut to reveal the connector. Note: Make sure you tighten the nut to remain IP rating. Check the o-ring on any defects as this may affect the IP rating.

When the USB connector is applied, the transmitter will be powered. All transmitter functionality is available. External power needs to be applied to power the VPSensorCartridge.

Install USB driver

When the transmitter is connected to the computer, please check the driver. The driver might have been installed automatically. If not, the driver needs to be installed manually. The driver can be found in the download area on our website www.vpinstruments.com/downloads. The driver for the VPFlowScope M must be used.

7.6 Ethernet

The transmitter has Ethernet functionality that can be used to communicate via Modbus over TCP, or to access the built in web server. A cable with M12 4 pin connector on one side and a RJ45 Ethernet connector on the other side can be used to connect the transmitter to a network or computer. [See chapter 10.5](#) for more information.

The default Ethernet settings can be found in the table below. These settings can be changed with VPStudio, via the web server or by using the key pad.

Default settings	
IP address	192.168.1.100
Net mask	255.255.255.0
Gateway	192.168.1.254
Web server port*	80
Modbus port*	502

*Values are fixed and can not be changed

7.7 Wi-Fi

The Wi-Fi option offers a new way of connecting the transmitter. There are 2 modes available that both have their own behaviour. The paragraph below explains both options.

Access point

The transmitter will be in access point mode by factory default. An access point means that the it will set up its own Wi-Fi network. When you search for available networks with your laptop, tablet or phone, it will detect a new Wi-Fi network called VPM-62XXXXXX where 62XXXXXX is the serial number of this transmitter. A connection can be set up between your device and the transmitter. Once connected, you are able to access the internal web server or to communicate via Modbus tcp. When connecting to the access point, a password is required. The default password is set to 123456789. The name and password of your access point can be changed with VPStudio or by using the internal web server.

The access point has a default IP address which is 192.168.240.1. This IP address can not be changed. Use this IP address to access the internal web server or when using Modbus TCP. The access point is configured to use DHCP. Therefore the access point will assign IP addresses to the connected devices.

Up to 5 devices can connect to the access point at the same time. Note that only one can have an active Modbus tcp connection. All connected devices can connect to the internal webserver at the same time.

This mode is typically used when connecting your device to the VPFlowScope M for configuration or read out of measurement values.

Client mode

A transmitter in client mode can be compared with your laptop or smartphone. It is a device that can be connected to an available Wi-Fi network, for example your office network. VPStudio or the internal web server can be used to select an available Wi-Fi network. It will scan for available networks. You can select one of these networks and connect to it. A password to this network might be required. Once connected, the other devices in this Wi-Fi network can access the internal web server or communicate with the transmitter via Modbus tcp.

This mode is typically used for integration of the VPFlowScope M in existing WiFi networks.

Scanning for networks

A scan for networks is a time consuming operation. It might take a while for this operation to be complete. During this scan, your Wi-Fi connection will be switched off. When scanning via the internal web server, you will receive a notification about your Wi-Fi being switched off. The connection will be set up automatically when Wi-Fi becomes available again. If this doesn't happen, the web server will notify you.

DHCP

Client mode can be used with DHCP or with a static IP address.

- DHCP: The WiFi network will provide the transmitter with an available IP address. This may vary in time.
- Static IP: You can enter your own IP address. Note that this needs to match with the IP range of your Wi-Fi network.

Default settings when in client mode with static IP	
IP address	192.168.1.101
Net mask	255.255.255.0
Gateway	192.168.1.254

General information

Wi-Fi Icon

The icon can be found in the menu of the data acquisition screen. It provides information about the current status.

Icon behaviour	Explanation
No icon	Wi-Fi signal is switched off. There is no connection with a network and the transmitter has not set up its own network
Icon blinking black	Wi-Fi signal is switched on. The transmitter is trying to connect to an available network or is trying to set up its own access point.
Icon continuously black	Wi-Fi signal is switched on. A connection with an available network is established or an access point has been set up successfully.
Icon continuously red	Wi-Fi signal is switched on. The transmitter failed to connect to an available network or it failed to set up its own access point.

Wi-Fi status

A status overview can be found in the menu of the transmitter. Go to: menu->settings->Wi-Fi->Wi-Fi status to view the actual status. The status menu will provide information about the actual connection when connected to a network or when a network has been set up by the transmitter itself. The actual status of the Wi-Fi interface will be displayed. Various status and error messages are available and can be found in the table below.

Status messages
Connected with a network
Connecting to a network
Wi-Fi is on and in client mode
Wi-Fi is off and in client mode
Access point started
Setting up access point
Wi-Fi is on and in access point mode
Wi-Fi is off and in access point mode
Scanning for networks
Wi-Fi is on
Wi-Fi is off

Error messages
No error
Error [code]
Unable to connect to network
Unable to start access point
Incorrect password

7.8 Internal web server

The built in web server can be accessed by entering the IP address in any web browser. A website will appear that enables you to view and adjust the devices settings. It also provides real time data visualisation of all available parameters. The data will be updated every second. The image below shows the internal web server. In order to access the web server, make sure the device is powered. USB power is sufficient for general configuration. External power needs to be applied to receive real time read out.

Login

Some part of the web server are password protected. These parts are the ones where settings can be adjusted. Product details and measurement values are available without logging in. The default credentials are:

username: admin

password: admin

Above credentials can be changed via the internal web browser, once logged in, or using VPStudio.

7.9 Modbus TCP

Modbus TCP can be used to connect the transmitter to VPVision or a central data acquisition / building management system.

When connecting to a building management system, it's important to match the Ethernet or Wi-Fi settings. The Ethernet and Wi-Fi settings can be changed with VPStudio, the built in web server or by using the key pad. Make sure that Modbus master and the transmitter are in the same IP address range.

The communication protocol used is Modbus TCP. The Modbus table is identical to the RS485 interface. More information can be found in the [Modbus chapter 9](#).

7.10 Display

The display enables you to read measurement data in real time. In combination with the keypad, it can also be used to change the most common parameters.





7.10.1 Display

The display provides 3 rows for real time data. Each row can be configured in the menu by selecting the desired parameter for this row. Available options are listed in [menu -> display](#). When flow or velocity is chosen to be displayed, a direction indicator will be displayed as shown in the image below. The arrow to right will turn green in case of positive flow. The arrow to left will be red in case of negative flow. The measurement value will also show a minus sign in case of negative flow.

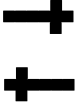

7.10.2 Display status icons

Some status icons show feedback on the meters' status. Below is a list with explanation.

Icons	Description
	VP Sensor Cartridge is properly connected and supplied with power
	No communication with the VP Sensor Cartridge
	A blinking dot will indicate that a data session is currently logging. (only applicable for transmitter models with integrated data logger)
	The key pad is locked. The menu can not be accessed
10%	Used memory indication (only applicable for transmitter models with integrated data logger)
	Active link via Ethernet cable
	Ethernet disconnected

Icons	Description
	Wi-Fi radio signal active. This icon will start blinking when connecting to a network. The icon will become red when Wi-Fi fails to connect to your network.

7.10.3 Custom units

Custom units can be used to create units that are not available in the display. They can be selected as unit for one of the three available display row positions. When selected on a row, they will be shown on the data acquisition screen. There are 5 custom unit positions available.

A custom unit consist of a base unit, a multiplying factor and a label. For example:

- Base unit: m^3_n/hr
- Label: SCFM
- Factor: 0.58

If the actual flow is $10 m^3_n/hr$, the display will show 5.8 SCFM

7.10.4 Keypad

The key pad contains 4 buttons to control the transmitter.

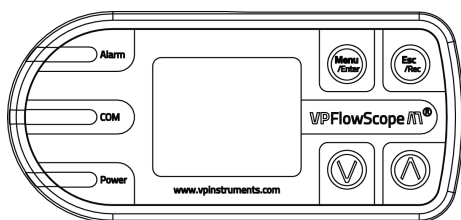

Menu / Enter

Used to enter the (sub)menu or to confirm a setting

Escape / Record

Will start a data logging session when in the data acquisition screen

Will return from a (sub)menu when not in the data acquisition screen

Button up

Navigate up in the menu

Button down

Navigate down in the menu

Lock key pad

When the data acquisition screen, press up and down simultaneously to lock or unlock the display. A lock icon will appear in the left upper corner of the screen.

7.10.5 Menu

The menu is categorized into 5 main items and 3 menu levels which contain their own sub menu items. The complete menu structure is shown below:

Menu level 1	Menu level 2	Menu level 3
1. Settings	1. Diameter	1. mm
		2. inch
	2. Display	1. Rows
		2. Dim time
		3. Orientation
	3. Date and Time	
	4. Modbus address	
	5. Analogue output	1. Mode
		2. Pulse settings
		3. 4..20mA settings

	6. Ethernet	
	7. Wi-Fi	Wi-Fi on/off
		Wi-Fi IP settings
		Switch Wi-Fi mode
		Wi-Fi Status
2. Data logger	1. Change mode	
	2. New session	
	3. Delete session	
	4. Delete all sessions	
3. Alarm	1. Mode	
	2. Unit	
	3. Boundaries	
	4. Periods	
4. Info / about		
5. Factory reset		
6. Restart		

1 Settings

The settings menu can be used to change both functional parameters as display settings.

1.1 Diameter

For correct operation, the exact inner pipe diameter has to be set. Changing the diameter is only possible when the VPSensorCartridge is connected. When the menu is entered, first select the desired unit, this can be in mm or inch. Now enter the inner pipe diameter and confirm by pressing enter. Using the wrong inner pipe diameter will result in incorrect flow readings.

1.2 Display

1.2.1 Rows

The data acquisition screen of the display contains 3 rows to display measurement values. Via this menu measurement values can be assigned to these rows. Available options in the menu are:

Measurand	Available units	Description
Empty	-	Leave this display row empty
Flow	m _n /sec sfps m ³ _n /hr m ³ _n /min m ³ _n /sec l _n /min l _n /sec SCFM	Normalized
Pressure	bar (g) psi (g)	Gauge
Temperature	°C °F K	
Totalizer	m ³ _n MSCF	Normalized to 0 degrees C, 1013,25 mbar

Custom		5 available units to be configured with VPStudio. Multiply an existing unit with a user defined factor.
--------	--	---

* All flow & velocity units are under normalized conditions (DIN 1343)

1.2.2 Dim time

The display back light dim time can be adjusted here. The default dim time is set to 10 seconds.

Other Available options are:

- No dimming. The back light will remain on
- 5 till 30 seconds with steps of 5 seconds

1.2.3 Display orientation

The text on the display can be set upside down for installations where the transmitter display is upside down. Enter the menu item and select the desired orientation with the arrow keys. Confirm with enter to make these settings active.

The key pad will maintain their normal function.

1.3 Date and time

Adjust date and time settings. First enter the menu option and set the date with the key pad. The date is formatted as: DD-MM-YYYY. After setting the date, confirm with enter and then enter the time settings in format: HH:MM:SS, again confirm with enter. The new date will become active immediately.

Date/time settings are kept actual by the real time clock. This clock is powered by a backup battery which will power the clock when external power is removed. The life time of this battery is approximately 1 week. If the battery is empty, date and time will reset to factory default: 1 January 2011. Date and time can also be synchronized with the computer when used with VPStudio.

1.4 Modbus address

The Modbus address can be changed with this option. Use the up and down buttons to change the number. Available numbers 1 – 247. After setting the number press enter to save the address.

1.5 Analogue output

1.5.1 Mode

The analogue output can be used in 3 different modes. You will need to choose one which can be:

- 4..20mA mode
- Pulse mode
- Alarm mode

1.5.2 Pulse settings

First select the desired unit, this can be m^3_n or MSCF. Then adjust the desired pulse size.

1.5.3 4..20mA settings

Select the desired unit to route to the analogue output. There can only be 1 unit at a time. After selecting a unit, the zero (corresponding with 4mA) and span (corresponding with 20mA) values can be set. [See chapter 7.2 4..20mA output](#) for more information.

1.6 Ethernet

Change the IP address, net mask and Gateway. Use the enter button to iterate through the IP segments.

1.7 Wi-Fi

Wi-Fi on/off

Switch Wi-Fi on or off. This will enable/disable the radio signal.

Wi-Fi IP settings

Change the IP address, net mask and Gateway. Use the enter button to iterate through the IP segments. (only available in client mode)

The Wi-Fi can also be put into DHCP mode where the router will assign a IP address to the transmitter.

Switch Wi-Fi mode

Switch between access point and client mode.

Wi-Fi status

You can see the actual status of the Wi-Fi connection. It will show you the active Wi-Fi mode (access point / client mode), the active IP address and the latest error if available.

2 DAQ Sessions

2.1 Change mode

The transmitter features 2 different data logging modes which are cyclic and start/stop. Select the desired mode. Changing the data logging mode will remove all stored data.

2.2 Start/stop session *(This option is only available when in multi-session mode)*

The session will be started when you push the enter button after selecting this option. When the session is started, the menu will close and the main screen will be shown. A blinking dot in the right upper corner will indicate the running session.

2.2 Delete session *(This option is only available when in multi-session mode)*

Select the desired session to be removed. Confirm removal by pressing enter.

2.3 Delete all

All sessions will be deleted. Confirm removal by pressing enter.

[See chapter 8 data logger](#) for more information.

3 Alarm

3.1 Mode

Select the desired alarm mode which can be off, lower boundary, upper boundary and both boundaries.

3.2 Unit

Select the desired measurement parameter alarm input.

3.3 Boundaries

Set upper and/or lower boundaries for alarm triggers.

3.4 Period

Set the hold and reset period for alarm events.

3.5 Reset

Reset the alarm counter. The alarm counter can only be reset to zero.

[See chapter alarm](#) for more information.

4 Info/about

Shows all general information of the transmitter and the VPSensorCartridge, if connected.

5 Factory reset

The transmitter will be put back in factory default settings. All session will be deleted. A request for reset needs to be confirmed by pressing the up and down button simultaneous. The factory reset can also be triggered using VPStudio.

6 Restart

Restart the device. All peripherals will be reinitialized.

7.11 Data logger

The optional data logger enables you to record data. Data can be recorded for a period of at least 6 months with an interval of 1 second for each parameter. The data can be extracted with VPStudio.

There are 2 different modes available, explained below. The modes can be changed with VPStudio or by using the key pad. **Changing the mode will remove all stored data.**

Data will only be recorded when a VPSensorCartridge is connected and when the main power is connected to the transmitter.

7.11.1 Cyclic mode

We developed cyclic data logging mode as an "install and forget" feature. When this mode is selected. Data will be recorded at all times, when power is applied and a sensor is connected. The data logger will start automatically with a 1 second interval for all available parameters. When the memory is full, the oldest data will be removed automatically. Total capacity is at least 6 months.

7.11.2 Multi session mode

This mode enables you to start or stop one session manually by using the key pad. When started, the data logger will record data on the user defined intervals.

Use the following guidelines for the intervals

Application	Flow	Pressure	Temperature
Standard energy management application	5 min	5 min	5 min
Machine testing - quick fluctuations	1 sec	1 sec	1 sec
Audit - one week	10 sec	10 sec	5 min
Audit - one month	30 sec	30 sec	5 min

Multiple sessions can be recorded. When a session is started, a separate session will be recorded. It's not possible to append to an existing session.

When a power failure occurs during recording, the session will be stopped. When power is restored, a new session will start automatically.

8 Alarm

The transmitter has a built-in alarm module. The input for an alarm is one of the available measurement values. The required measurement unit for this value can be selected as desired. The selected input will be compared to the configured boundaries.

Boundaries and modes

2 boundaries are available:

- Upper boundary
- Lower boundary

The selected measurement value will be compared with one or two of the boundaries depending on the mode. There are 4 modes available:

1. Do not compare (alarm off)
2. Compare with upper boundary
3. Compare with lower boundary
4. Compare with both boundaries

Hold period

The hold period indicates the amount of time that the measurement value needs to overstep the alarm boundaries.

For example:

The upper boundary is set to 7 bar

The hold time is set to 10 seconds

If the pressure is 7.1 bar for 9 seconds, no alarm will be triggered

If the pressure is 7.1 bar for 10 seconds, an alarm will be triggered

Reset period

The reset period indicates the length of time that an alarm will remain active. After the set period of time, the alarm will reset.

An active alarm can be shown in various ways:

- The red LED will turn on
- The alarm status can be read out with Modbus
- The current output will signal 20mA (when in alarm mode)

Counter

An alarm counter is available that counts the number of triggered alarms. Every alarm event will add up 1 to the alarm counter. The alarm counter can be read out by Modbus.

The alarm counter can be reset to zero with the keypad, with Modbus, or with VPStudio. The alarm counter value is written to its internal memory with an interval of 15 minutes. A power failure may result in a maximum of 15 minutes of alarm counter loss.

9 Modbus

Introduction to Modbus

For a complete introduction on the Modbus standard can be found on www.modbus.org. See the document [Modbus_over_serial_line_V1_02.pdf](#), which can be downloaded from their website. We strongly recommend to download and read this information carefully before installing Modbus communication. The following paragraphs in this chapter assume you are familiar with the Modbus communication standard.

All measurement parameters are available through Modbus in floating point and integer format. The data will be refreshed every second. Maximum polling interval is 10ms.

The Modbus settings can be changed with VPStudio, the built in web server or with the key pad when available. Below shows all available options

- Hardware address: 1-247
- Integer multiplier: 1-1000

Data format

Function code 0x03 for reading(Holding register)

Function code 0x06 for writing single register(Holding register)

Function code 0x10 for writing multiple registers(Holding register)

Data format is in little endian

Register map

The actual measurement data is placed in holding registers. To read out data, you will need to use the corresponding holding registers.

HEX	Decimal	Description	Type	Read / Write
<u>General information</u>				
0001 - 0002	1 - 2	Serial number	32-bit integer	Read
0003 - 0005	3 - 5	Firmware version	3 bytes	Read
0006 - 0007	6 - 7	Production date	32-bit integer	Read
<u>VPSensorCartridge data</u>				
0032 - 0033	50 - 51	Serial number	32-bit integer	Read
0034 - 0036	52 - 54	Firmware version	3 bytes	Read
0037 - 0038	55 - 56	Calibration date (timestamp)	32-bit integer	Read
0039 - 003A	57 - 58	Production date (timestamp)	32-bit integer	Read
003D - 003D	61 - 61	VPSensorCartridge error code	16-bit integer	Read
003E - 003E	62 - 62	VPSensorCartridge status	16-bit integer	Read
<u>Flow</u>				
0064 - 0065	100 - 101	Flow range min m_n /sec	Floating point	Read
0066 - 0067	102 - 103	Flow range max m_n /sec	Floating point	Read
0068 - 0069	104 - 105	Flow m_n /sec	Floating point	Read
006A - 006B	106 - 107	Flow sfps	Floating point	Read
006C - 006D	108 - 109	Flow m^3_n /hr	Floating point	Read

006E - 006F	110 - 111	Flow m^3_n /min	Floating point	Read
0070 - 0071	112 - 113	Flow m^3_n /sec	Floating point	Read
0072 - 0073	114 - 115	Flow l_n /min	Floating point	Read
0074 - 0075	116 - 117	Flow l_n /sec	Floating point	Read
0076 - 0077	118 - 119	Flow SCFM	Floating point	Read
0082 - 0083	130 - 131	Flow m_n /sec	32-bit integer	Read
0084 - 0085	132 - 133	Flow sfps	32-bit integer	Read
0086 - 0087	134 - 135	Flow m^3_n /hr	32-bit integer	Read
0088 - 0089	136 - 137	Flow m^3_n /min	32-bit integer	Read
008A - 008B	138 - 139	Flow m^3_n /sec	32-bit integer	Read
008C - 008D	140 - 141	Flow l_n /min	32-bit integer	Read
008E - 008F	142 - 143	Flow l_n /sec	32-bit integer	Read
0090 - 0091	144 - 145	Flow SCFM	32-bit integer	Read
<u>Pressure</u>				
0096 - 0097	150 - 151	Pressure range min bar gauge	Floating point	Read
0098 - 0099	152 - 153	Pressure range max bar gauge	Floating point	Read
009A - 009B	154 - 155	Pressure bar gauge	Floating point	Read
009C - 009D	156 - 157	Pressure psi gauge	Floating point	Read
00B4 - 00B5	180 - 181	Pressure bar gauge	32-bit integer	Read
00B6 - 00B7	182 - 183	Pressure psi gauge	32-bit integer	Read
<u>Temperature</u>				
00C8 - 00C9	200 - 201	Temperature range min °C	Floating point	Read
00CA - 00CB	202 - 203	Temperature range max °C	Floating point	Read
00CC - 00CD	204 - 205	Temperature °C	Floating point	Read
00CE - 00CF	206 - 207	Temperature °F	Floating point	Read
00D0 - 00D1	208 - 209	Temperature K	Floating point	Read
00E6 - 00E7	230 - 231	Temperature °C	32-bit integer	Read
00E8 - 00E9	232 - 233	Temperature °F	32-bit integer	Read
00EA - 00EB	234 - 235	Temperature K	32-bit integer	Read
<u>Totalizer</u>				
00FA - 00FB	250 - 251	Totalizer m^3_n	Floating point	Read
00FC - 00FD	252 - 253	Totalizer positive m^3_n	Floating point	Read
00FE - 00FF	254 - 255	Totalizer negative m^3_n	Floating point	Read
0100 - 0101	256 - 257	Totalizer MSCF	Floating point	Read
0102 - 0103	258 - 259	Totalizer positive MSCF	Floating point	Read

0104 - 0105	260 - 261	Totalizer negative MSCF	Floating point	Read
0113 - 0114	275 - 276	Totalizer m_n^3	32-bit integer	Read
0115 - 0116	277 - 278	Totalizer positive m_n^3	32-bit integer	Read
0117 - 0118	279 - 280	Totalizer negative m_n^3	32-bit integer	Read
0119 - 011A	281 - 282	Totalizer MSCF	32-bit integer	Read
011B - 011C	283 - 284	Totalizer positive MSCF	32-bit integer	Read
011D - 011E	285 - 286	Totalizer negative MSCF	32-bit integer	Read
<u>Alarm</u>				
012C - 012C	300 - 300	Alarm mode	16-bit integer	Read / write
012D - 012D	301 - 301	Alarm hold period	16-bit integer	Read / write
012E - 012E	302 - 302	Alarm reset period	16-bit integer	Read / write
012F - 012F	303 - 303	Alarm unit	16-bit integer	Read / write
0130 - 0131	304 - 305	Alarm counter	32-bit integer	Read
0132 - 0132	306 - 306	Alarm status	16-bit integer	Read
0136 - 0137	310 - 311	Alarm low boundary *	Floating point	Read / write
0138 - 0139	312 - 313	Alarm high boundary *	Floating point	Read / write
<u>Configuration registers</u>				
03E8 - 03E8	1000 - 1000	Totalizer reset all		Write
03E9 - 03E9	1001 - 1001	Alarm counter reset		Write
041A - 041B	1050 - 1051	4..20mA zero *	Floating point	Read / write
041C - 041D	1052 - 1053	4..20mA span *	Floating point	Read / write
041E - 041F	1054 - 1055	Pulse size m_n^3 *	Floating point	Read / write
0420 - 0421	1056 - 1057	Pulse size SCF *	Floating point	Read / write
0422 - 0422	1058 - 1058	4..20mA unit	16-bit integer	Read / write
0423 - 0423	1059 - 1059	I-out mode	16-bit integer	Read / write
044C - 044D	1100 - 1101	Diameter mm *	Floating point	Read / write
044E - 044F	1102 - 1103	Diameter inch *	Floating point	Read / write
04B0 - 04B0	1200 - 1200	Modbus address	16-bit integer	Read / write
04B1 - 04B1	1201 - 1201	Modbus multiplier	16-bit integer	Read / write

* Value will only change if both registers are written

VPSensorCartridge connection status

Modbus return value	Description
0	No VPSensorCartridge connected
1	VPSensorCartridge is connected
2	VPSensorCartridge is connected but not powered
3	VPSensorCartridge error, see error code and contact local distributor

Available write operations

Option	Data	Description
Analogue output mode	0	4..20 mA mode
	1	Pulse mode
	2	Alarm mode
	Other	4..20 mA mode
4..20mA and alarm unit	0	m _n /sec
	1	sfps
	2	m ³ _n /hr
	3	m ³ _n /min
	4	m _n /sec
	5	l _n /min
	6	l _n /sec
	7	SCFM
	8	bar
	9	psi
	10	°C
	11	°F
	12	K
Other	m _n /sec	
Alarm mode	0	Alarm off
	1	Alarm on low boundary
	2	Alarm on high boundary
	3	Alarm on both boundaries
	Other	Alarm on both boundaries

10 Electrical connections



NEVER USE AC POWER. THIS WILL VOID WARRANTY AND BRING PERMANENT DAMAGE TO THE ELECTRONICS. THE INSTRUMENT MIGHT BE DAMAGED BEYOND REPAIR.
CONNECT THE M12 CONNECTOR BEFORE POWERING UP THE INSTRUMENTS.

The transmitter is equipped with a M12 5-pin connector which contains the power input, an analogue output and a Modbus interface.

Pin	Signal	Wire color
1	+12...24 VDC	Brown
2	0 Volt	White
3	4..20 mA signal, active	Blue
4	RS485 B	Black
5	RS485 A	Grey

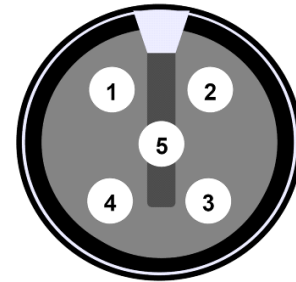

M12 5-pin female connector

Cabling

Shielded twisted pair cabling must be used for proper communication and measurement. Connect shield to safety ground on one point. The thickness of the wires depends on the cable length. For cabling below 300 meter | 1000 ft, use 20 awg. For longer runs use 18 awg or better.

Power supply

The input voltage is 12 to 24VDC. Make sure that the power supply is at least 12V at the connector. Voltage drops will occur in long cables resulting in insufficient power. The display will notify you when there is insufficient power.

10.1 4..20mA

An advantage of a current loop is that the accuracy of the signal is not affected by voltage drop over the line. Even if there is significant electrical resistance in the line, the current loop transmitter will maintain the proper current, up to its maximum voltage capability. The live-zero represented by 4mA allows the receiving instrument to detect some failures of the loop. An analogue current loop can be converted to a voltage input with an external third party precision resistor.

The transmitter output is an active, non- isolated linearised current loop. This means that the + wire is shared between power supply and the analogue output. A current will draw back from the instrument to the power supply.

Cabling

3 wires are required to create a current loop. It is advised to use a shielded cable to prevent electrical noise to affect the signal.

Ohm's law can be used to calculate the maximum distance. There are 2 parameters that needs to be taken into account.

1. The voltage available is equal to the input voltage
2. The resistance depends on cable quality and length

Example:

Input voltage 24V
 Required maximum current 20mA

$$24V / 0.02A = 1200 \text{ Ohm}$$

1200 Ohm is the maximum load that can be applied with a 24V input level.

Above example does not include the current consumption of the flow meter itself. When power to the flow meter is applied using a long cable, include a current consumption of 500mA to the formula.

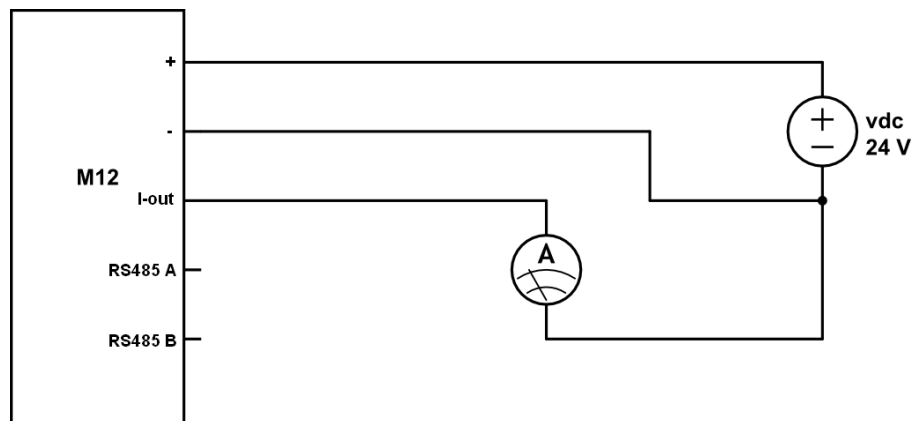
Electrical scheme

The current meter is placed in between the current output and the power supply ground. You can also use a digital multimeter to test the current output.

10.2 Pulse

The pulse output is an active non potential free current output. This means that the + wire is shared between power supply and the pulse output. The output signal will be 0mA in idle state. When a pulse is generated, a 20mA signal will be outputted for 1 second.

The counter can be placed between the pulse output and the power supply - (neg).

Cabling

The electrical specifications are identical to the 4..20mA output. Therefore the suggested cabling is identical.

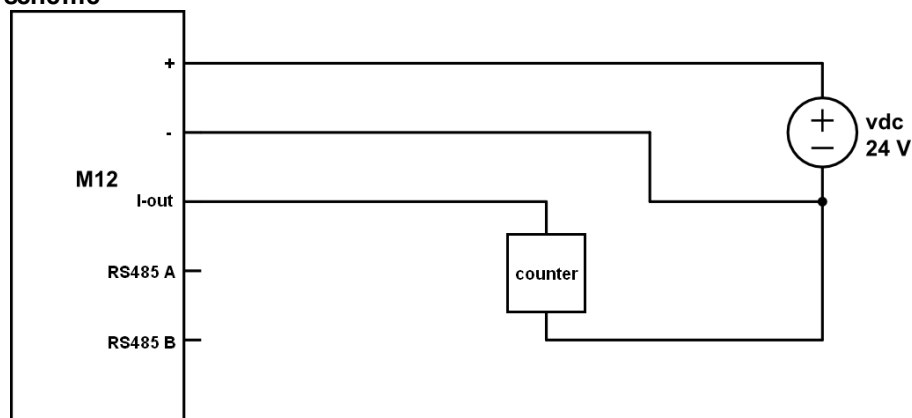
Electrical scheme

10.3 Alarm

The alarm output is an active non potential free current output. This means that the + wire is shared between power supply and the alarm output. The idle current will be 0mA. When an alarm is triggered, the alarm output will go to 20mA. The alarm output can be wired into a central data acquisition / building management system as signal. An external control current relay is required to switch on lamps or buzzers. When selecting a relay, make sure that the input can be controlled by a current signal.

Cabling

The electrical specifications are identical to the 4..20mA output. Therefore the suggested cabling is identical.

Electrical scheme

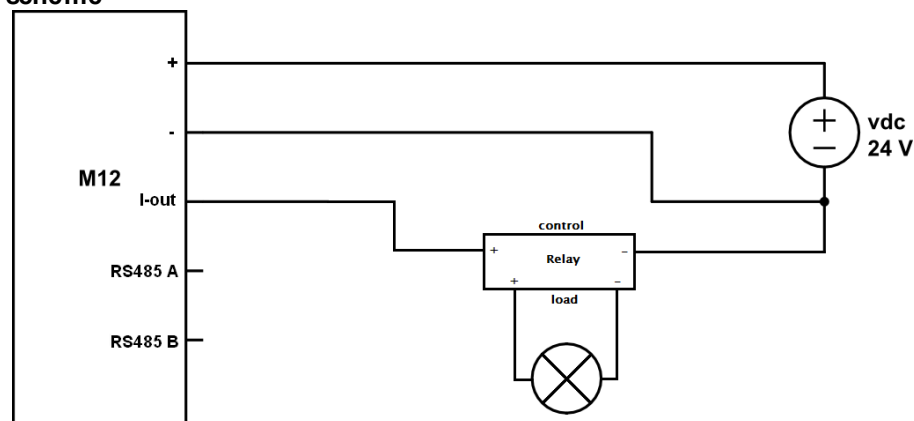

10.4 RS485



Installing an RS485 network requires specific knowledge. Not following the specifications strictly might result in incorrect communications and equipment damage. Please leave installation up to professional contractors. Make sure that they read this chapter carefully and follow up all RS485 guidelines.

RS485 is a differential balanced line over twisted pair. It can span relatively large distances up to 1200 meter | 4000 feet. The wires should be connected as a point-to-point configuration, or also called daisy chain. Do not install as star or ring network! The trunk line goes from the master to all devices making a drop down to each device. The cable length from the trunk line to the Modbus device needs to be as small as possible. Junction boxes are used to make the T junction.

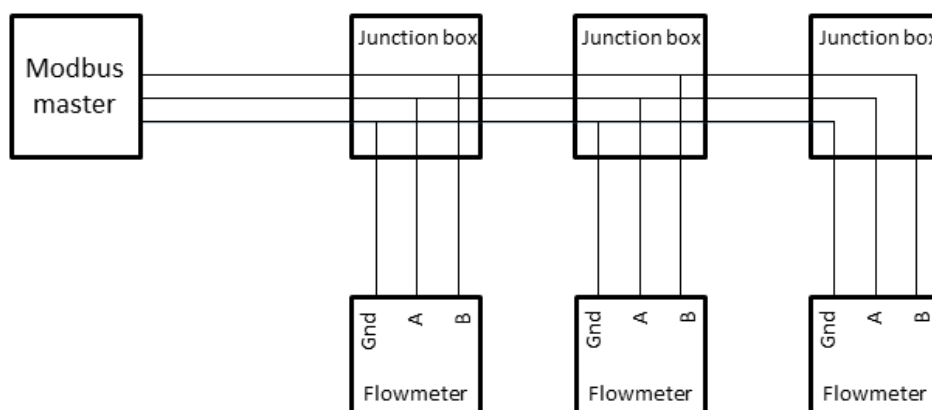

Shielded twisted pair should be used. Connection of a third wire between the master and slave should be done to limit the common mode voltage that can be impressed on the slaves inputs. The required cable quality depends on the total cable distance, the number of nodes and the environmental influences. A local contractor can help you select the right cable for your application.

Termination resistor

Termination resistors reduce electrical noise sensitivity. They need to be added to the installation when cable distances become longer than 10 meter. The value of each termination resistor should be equal to the cable characteristic impedance (typically, 120 ohms for twisted pairs).

There can only be one termination resistor at the very end of the trunk line. The VPInstruments junction box features a jumper that can be used to enable a 120 Ohm resistor. When using the VPInstruments Modbus Junction boxes make sure that the 120 Ohm resistor is only enabled in the last Modbus Junction box in the daisy chain.

Biasing

When there is no data activity on an RS485 network, the communications lines are "floating" and, thus susceptible to external noise or interference. Receivers on a RS485 network have built in hysteresis (200mV differential required to insure known state). To insure that a receiver stays in an inactive state, when no data signal is present, bias resistors are required. Bias resistors are a pull-up resistor on Modbus B and a pull-down resistor on the Modbus A line. The value of the bias resistor depends on the number of devices and the supply voltage. The table below shows which resistor values can be used for different voltage in a chain with 1 to 8 VPFlowScope M's.

Supply voltage	Bias pull up	Bias pull down
12 V	5 K Ω	1 K Ω
24 V	10 K Ω	1 K Ω

Bus power

The VPFlowScope M can be powered via the same trunk line. 2 separate wires are used for power + and power -. Take in account that long wires with multiple slaves will cause voltage drops. The minimum supply voltage is 12VDC measured at the last VPFlowScope M in the daisy chain.

Electrical scheme

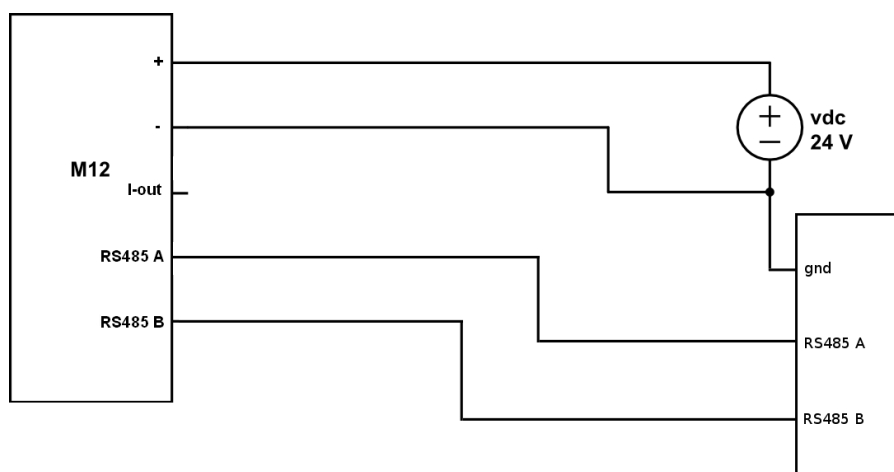

10.5 Ethernet

Ethernet is available through a M12 4-pin d-coded connector. It uses the industry standard pin-out for Ethernet. The table below shows how to wire from M12 to the RJ45 Ethernet plug. When creating your own cable, make sure that shielded twisted pair (STP) wire is used. The maximum length for all Ethernet cables is 150 meter.

M12 Pin	Ethernet pin	Wire color
1	1	White / Orange
2	3	White / Green
3	2	Orange
4	6	Green

T568B standard



M12 4-pin female connector

We offer 2 types of cables for connecting your transmitter to the Ethernet.

Order code	Connectors	Description
VPA.5004.0005	M12 to RJ45	Connection to routers or switches 5 meter 16.4ft
VPA.5004.0105	M12 to M12	Extension cord 5 meter 16.4ft

11 VPStudio software

The VPFlowScope M can be read out and configured with the VPStudio software. This software can be downloaded from www.vpinstruments.com. VPStudio is available for Windows and has been tested on version: Windows 7, 8 and 10.

A quick start is shown below, read the VPStudio manual for more information. This manual can be downloaded from www.vpinstruments.com/downloads.

Connect the transmitter to the computer

The transmitter can be connected to the computer with USB for configuration and read out. Connect the VPSensorCartridge to the transmitter for information about the VPSensorCartridge. The VPSensorCartridge parameters is read only, nothing can be changed here.

Install USB driver

When the transmitter is connected to the computer, please check the driver. The driver might have been installed automatically. If not, the driver needs to be installed manually. The driver can be found in the download area on our website www.vpinstruments.com/downloads. Instructions on how to install the driver are enclosed with the driver.

Configure the transmitter

- Start the VPStudio software
- The software will recognize the instrument. A device will appear in the left menu bar
- Click overview for the basic parameters
- Click settings to change the transmitters settings
- Click data logger to retrieve recorded data

Firmware update

A firmware updater is available in the VPStudio software. In the software, click the update button in the left menu. Select the firmware file provided by VPInstruments. Click the update button. The transmitter will reboot en start updating. VPStudio will provide feedback on succession or failure.

12 Exchanging VPSensorCartridges

With the patented VPSensorCartridge concept, traditional re-calibration is something no longer required. From now on, you simply exchange the VPSensorCartridge, and continue your measurements with nearly zero downtime. All settings are stored in the transmitter and are automatically transferred to the newly installed VPSensorCartridge.

Your benefits:

- Near zero downtime
- Less logistics/customs cost and involvement

Exchanging instructions can be found in [chapter Replacing the VPSensorCartridge](#).

13 Specifications transmitters



Please always check the label of your product for the specifications.

Specifications are subject to change as we are continuously improving our products. Please contact us to obtain the latest specification sheet.

Sensor interface

VPSensorCartridge Proprietary interface, rotational 360 degrees

Display

Display type 1.8" TFT color with auto power save (option)
LED status LED indicators on all models for power, communication and alarm

Data logger

Memory At least 6 months @ 1 x per second logging interval for all parameters
Logging mode Cyclic and start/stop

Outputs

RS485 Modbus RTU
Analogue output 4..20mA output or pulse or alarm (selectable)
USB Mini USB, behind o-ring sealed cap for configuration
Ethernet Communication via Modbus TCP and access to built in web server
Wi-Fi Communication via Modbus TCP and access to built in web server
Wi-Fi radio 2.4GHz 802.11 b/g/n channel 3
Wi-Fi output power +15dBm (max)

Mechanical & Environmental

Dimensions 50 x 108 x 36 mm | 1.97 x 4.25 x 1.42 inch
Weight 220 grams | 7.76 ounces including locking ring
Material Aluminium, anodized body with polycarbonate cover
O-ring seals NBR
Protection grade IP65 | NEMA 4 when mated to VPSensorCartridge and USB cap tightened
Ambient temperature 0..60°C | 32 .. 140°F
Ambient humidity 10 - 95%. Avoid condensation at all times

Avoid direct sunlight or radiant heat

Highly corrosive or acid environments should be avoided

Electrical

Supply 12VDC(*)..24 VDC +10% CLASS 2 (UL)
Power consumption 1 Watt (no flow) 3.5 Watt (full flow) +/- 10%

Certification

CE EN 60950-1, EN 61326-1, EN 61000-3-2, EN 61000-3-3, EN 61326-1
UL UL 508

** 12 Volt should be available at the input terminal under all flow conditions and all environmental conditions. Cable resistance and power supply impedance, which are temperature dependent, will cause permanent and transient voltage drops. These voltage drops have to be taken into account when designing and implementing the electrical installation. The VPFlowScope M continuously monitors available input voltage and will automatically turn into power save mode when the supply voltage drops below 11.8 Volt. For maximum power reliability under all circumstances, we recommend to use 24 VDC.*

14 Specifications VPSensorCartridges



Please always check the label of your product for the specifications.

Specifications are subject to change as we are continuously improving our products. Please contact us to obtain the latest specification sheet.

Flow sensor

Measuring principle	Thermabridge™ Thermal Mass Flow sensor
Flow range	0(0.5) ... 150 m _n /sec 0 ... 500 sfps
Bi-directional flow	Optional
Accuracy	2% of reading under calibration conditions
Reference conditions	0 °C, 1013.25 mbar 32 °F, 14.65 psi
Gases	Compressed air, Nitrogen and inert, non condensing gases
Gas temperature range	0 ... 60 °C 0 ... 140 °F

Pressure sensor

Pressure range	0 ... 10 bar 0 ... 145 psi gage
Accuracy	+/- 1% FSS (total error band) Temperature compensated

Temperature sensor

Temperature range	0...60 °C 32...140 °F
Accuracy	> 10m/sec: +/- 1 °C 1.8 °F < 10m/sec: + 5 °C 9 °F

Mechanical & Environmental

Probe Length	340 mm 13.4"
Weight	200 grams 7.05 ounces
Process connection	Compression fitting, 1/2" NPT, Tapered
Pressure rating	PN10
Protection grade	IP65 NEMA 4 when mated to transmitter
Ambient temperature range	0...60 °C 32...140 °F, avoid direct sunlight or radiant heat
Wetted materials	Anodized Aluminum, Stainless steel 316, Glass, Epoxy
Corrosion resistance	Highly corrosive or acid environments should be avoided

Electrical

Connection type	VPSensorCartridge proprietary
Power consumption	See transmitter specifications for combined power consumption

15 Order information and accessories

15.1 Transmitter

Order Code	Option	Feature
VPM.T0001	D000	Basic
	D010	Basic + display
	D011	Basic + display + data logger
	D111	Basic + display + data logger + Wi-Fi

Available models on day of printing

Basic features	Display features	Data logger	Wi-Fi
RS485 4..20mA, Pulse, Alarm Ethernet Alarms LEDS	3 line display Keypad for configuration	Traditional start/stop Cyclic At least 6 Months @ 1 sec interval	Wireless connection that can be used for Modbus tcp and access to the internal web server

15.2 VPSensorCartridge

Order Code	Flow	Temperature	Pressure	Bi-directional
VPM.R150.P350.PN10	√	√	√	
VPM.R150.P351.PN10	√	√	√	√

Available models on day of printing

15.3 Accessories

Accessories

VPA.5000.005	Cable, 5m / 16.4 ft with M12 5pin connector on one side, open wires on other side
VPA.5000.010	Cable, 10m / 32.9 ft with M12 5pin connector on one side, open wires on other side
VPA.0000.200	Power supply (12V, 5pin)
VPA.5004.0005	Ethernet cable, 5m / 16.4 ft with M12 4pin connector on one side, RJ45 on other side
VPA.5004.0105	Ethernet extension cable, 5m / 16.4 ft with M12 4pin female connector on one side, and male on other side
VPA.5004.0001	Compression fitting for VPFlowScope M with integrated safety system
VPA.5004.1001	Locking ring for VPFlowScope M
VPA.5014.003	Explorer case for VPFlowScope M

VPStudio software

SFT.5003.500	VPStudio 2.0
--------------	--------------

16 Appendix A - Underwriters Laboratories (UL)

The VPFlowScope M complies with the CE requirements as stated in the CE declaration. CE compliance can only be achieved when grounding and shielding directions are followed and proper cables and connector assemblies are used.



Electrical connection guidelines- UL 508 Listing for USA & Canada (Check label to see if product is UL marked)

The VPFlowScope M is intended to be used with a Class 2 power source or Class 2 transformer in accordance with UL1310 or UL1585. As an alternative a LVLC (Low Voltage Limited Current) power source, with the following properties can be used:

- The device shall be used with a suitable isolating source such that the maximum open circuit voltage potential available to the product is not more than 24 VDC and the current is limited to a value not exceeding 8 amperes measured after 1 minute of operation;
- A fuse in accordance with the UL248 series and rated max 4A, shall be installed in the 24V DC power supply to the device? In order to limit the available current.

Electrical connection guidelines: general remarks

Make sure that the following conditions are met:

- For portable, non-critical applications, a switched mode 12 VDC, 1A power adapter may be used. Switched mode power supplies that are of poor quality, might affect the accuracy.

Le VPFlowscope M est conforme aux exigences CE, comme indiqué dans la déclaration CE. La conformité CE ne peut être atteinte que lorsque les directives de mise à la terre et d'isolation sont suivies et que les câbles et raccords appropriés sont utilisés.



Lignes directrices pour branchements électriques – UL508 pour le Canada et les États-Unis (voir sur l'étiquette si le produit est marqué UL)

Le VPFlowscope M est prévu pour être utilisé avec une source d'alimentation Classe 2 ou avec un transformateur de Classe 2 en accord avec UL1310 ou UL1585. Comme alternative, une source d'alimentation BTCL (Basse Tension Courant Limité) avec les propriétés suivante peut être utilisée :

- Le dispositif doit être utilisé avec une source d'isolation appropriée afin que le voltage maximal en circuit ouvert disponible pour le produit ne dépasse pas 24VDC, et que le courant soit limité à une valeur de 8 ampères après 1 minute de fonctionnement.
- Un fusible de 4A maximum, et conforme à la série UL248 doit être installé dans la source d'alimentation de l'appareil afin de limiter le courant disponible.

Directives pour le raccordement électrique : remarques générales

Assurez-vous que les conditions suivantes sont remplies :

- Pour les applications mobiles, un adaptateur de type alimentation à découpage 12VDC, 1A peut-être utilisée. Cependant, un adaptateur de mauvaise qualité pourra affecter la précision.

17 Appendix B - Federal Communications Commission (FCC) Statement

An FCC grant of equipment authorization and an FCC ID are not required, but the equipment complies with FCC technical requirements.

