

Product Specification

SenseAir[®] S8-4B

Miniature infrared CO₂ sensor safety switch



SenseAir[®] S8-4B

Miniature infrared CO₂ sensor safety switch

General

The *SenseAir[®] S8-4B* CO₂ sensor module is designed to serve as a CO₂ safety switch when built-in into kerosene heaters. The sensor utilizes reliable and highly accurate infrared gas sensing technology. The electronic circuitry is optimized for low power consumption.

**Warning! ESD
sensitive device!**

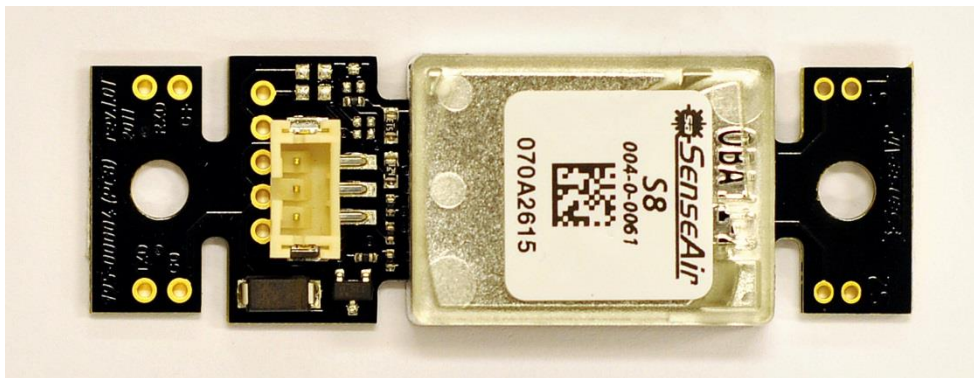

Figure 1. *SenseAir[®] S8-4B*

Functional description

During normal operation, the sensor measures ambient gas CO₂ concentration every 30 seconds and will set alarm output when CO₂ level is higher than 8000 ppm. A diagnostic routine will set Fault Alarm if any malfunction is detected. An alarm filter protects the sensor from issuing false alarm caused by intermittent short disturbances.

The alarm output is an open drain FET transistor switch which is in open state in normal operation and sinks the output pin to zero volts in alarm conditions. If any of the three alarm states CO₂ High, Power Low or Fault occur the unit sets the alarm. The output will stay in alarm mode until CO₂ level is below 6500ppm or other reason for alarm has been removed.

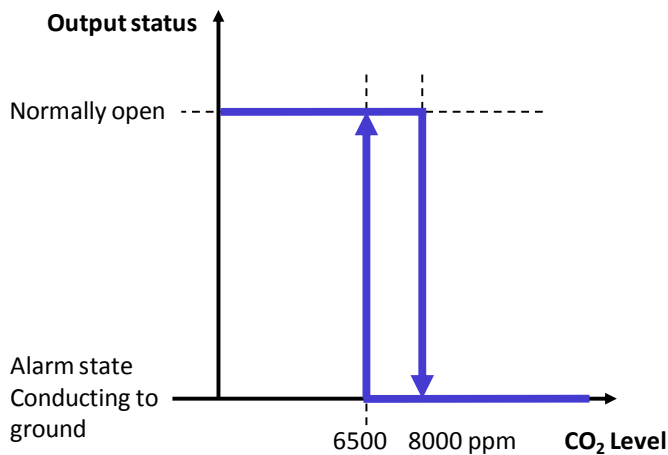

Figure 2. Alarm output

The unit will start operating at power supply voltages as low as 3.5V. First the micro-controller starts up in sleep mode for about 30 seconds, and then power supply voltage is checked and if it is higher than 4.5 V the CO₂ measurement sequence is started. During the measurement of CO₂, the power supply voltage is checked and must exceed 4.0 V. If power supply voltage drops below either of the thresholds the system will immediately set the output alarm and go to sleep mode for about 10 seconds. Then the system is actively discharged so that the alarm output, and the sensor itself, will reset as soon as the input voltage is totally gone. To assure an alarm reset, the power supply has to be disconnected for more than 40 seconds.

Item	<i>SenseAir[®] S8-4B Article no. 004-0-0061</i>
Target gas	CO ₂
Operating Principle	Non-dispersive infrared (NDIR)
Measurement range	400 to 32000ppm (represented internally in digital format)
Measurement interval	30 seconds
Accuracy	±1000ppm at alarm points between 7000 and 9000 ppm (Note 1)
Pressure dependence	+ 1.6 % reading per kPa deviation from normal pressure
Gas diffusion response time	2 minutes by 90%
Operating temperature	-5° to 60° C
Operating humidity range	0 to 95% RH non condensed
Storage temperature	-40° to +70°C
Storage Environment	0-95% RH non condensed non corrosive gases, no contamination
Dimensions (mm)	61 x 20 x 8.5 mm (max dimensions)
Weight	< 10 grams
Power supply	4.5 to 7.0 VDC unprotected against surges and reverse connection
Power consumption	250 mA peak, 2 mA average
Life expectancy	5+ years in normal indoor / office environments
Compliance with	Tested according Emission: EN 61000-6-3:2007, EN 61000-6-4:2007 Immunity: EN 61000-6-1:2007 RoHS directive 2011/65/EU
Output Alarm, Open Drain	Open drain FET; 7V/ 800mA, protected by a zener diode, normally open, 100kΩ pull-up resistor to power (+). 8000/6500 (Alarm/Release) Normal state is open. Transistor conducting at (CO ₂ > 8000ppm) OR (Unloaded Power voltage < 4.5V) OR (Loaded Power voltage < 4.0V) OR (Sensor Failure detected by self-diagnostics)
Maintenance	Forced calibration (assuming 400 ppm exposure).
Self-diagnostics	Full self-diagnostics at power up and continuously running self-diagnostics at every measurement.

Table 1. Key technical specification for the *SenseAir[®] S8-4B*

Note 1: Accuracy is specified over operating temperature range. Specification is referenced to certified calibration mixtures. Uncertainty of calibration gas mixtures (+2% currently) is to be added to the specified accuracy for absolute measurements.

Absolute maximum ratings

Stress greater than those listed in Table III may cause permanent damage to the device. These ratings are stress ratings only. Operation of the device at any condition outside those indicated in the operational section of these specifications is not implied. Exposure to absolute maximum rating for extended periods may affect device reliability.

Parameter	Minimum	Maximum	Units	Notes
Ambient temperature under bias	- 40	85	C	-
Voltage on G+ pin with respect to G0 pin	- 0.3	12	V	1
Maximum voltage on Calibration restore switch(S1) and	- 0.3	3.8	V	1
Maximum voltage on Output Alarm	- 0.3	G+ + 0.5	V	1, 2

Table 2. Absolute maximum ratings specification for the *SenseAir® S8-4B*

Note 1: Specified parameter relies on specification of subcontractor and is not tested by SenseAir

Note 2: OUT1 (Output Alarm) pin is internally pulled up to G+. External pull up to higher voltage will provide resistive divider powering sensor via high resistance.

Output electronic schematics

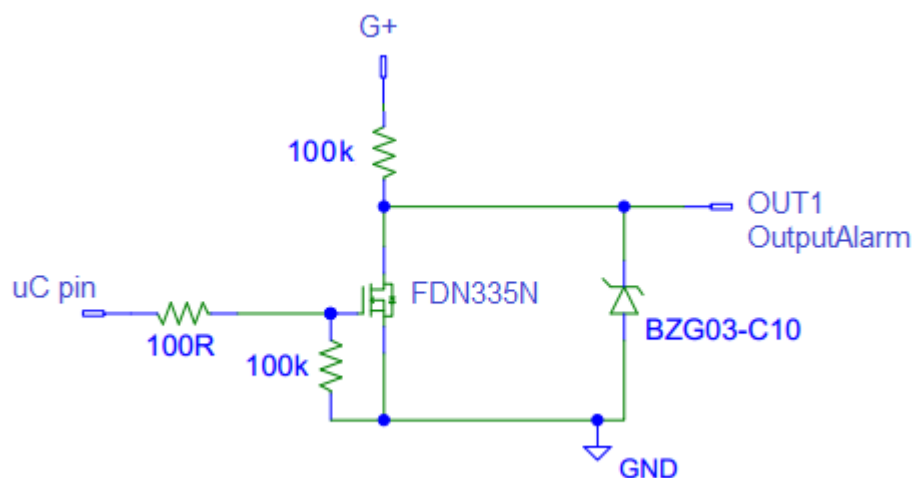

Figure 3. Output electronic schematics

Gas diffusion area

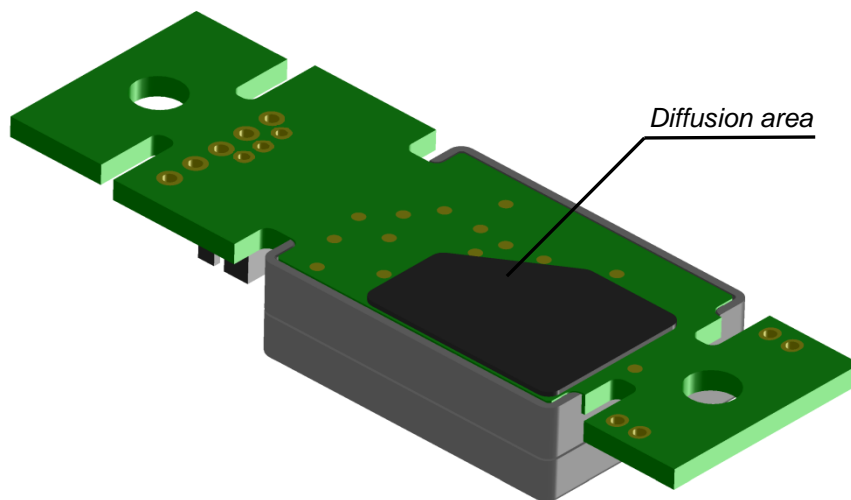

Figure 4. Gas diffusion area *SenseAir*[®] S8-4B

Pin assignment

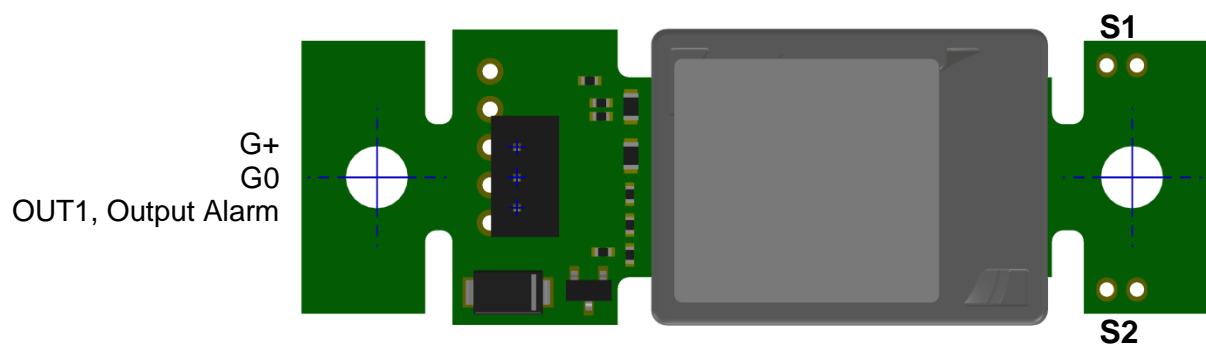

Figure 5. Pin assignment *SenseAir*[®] S8-4B

Terminals description

The table below specifies terminals and I/O options of the *SenseAir® S8-4B*.

The *SenseAir® S8-4B* is equipped with a 3-pin connector (G+, G0, Output Alarm).
Part number of the connector is B3B-PH-SM4-TB, manufacturer JST (www.jst.com).

Pin Function	Pin description / Parameter description	Electrical specification
Power supply		
G+	Power supply positive terminal.	Unprotected against reverse connection!
G0	Power supply negative terminal. Sensor's reference (ground) terminal.	Unprotected against reverse connection!
Outputs		
OUT1, Output Alarm	Open Drain FET transistor switch output. Internal protection. Absolute max voltage range(Note 1) Internal pull up to G+ resistor Max sink current (Note 1)	G0 - 0.3V to G+ + 0.5V 100k 800mA
Jumpers		
Calibration restore switch (S1)	Digital input forcing background calibration. Background calibration is activated when closed for minimum 30 seconds assuming 400 ppm CO ₂ sensor exposure. Calibration occurs every 30 seconds during switch grounding (Note 2) Absolute max voltage range(Note 1) Internal pull up resistor Input low level (Note 1) Input high level (Note 1)	No internal protection, Internal pull-up to 3.3V at processor reset (power up and power down) - 0.3V to 3.8V 120K - 0.3V to 0.75V 2.3V to 3.6V
Forced output test (S2)	Digital input forcing Output Alarm, for testing purpose. Absolute max voltage range(Note 1) Internal pull up resistor Input low level (Note 1) Input high level (Note 1)	No internal protection, Internal pull-up to 3.3V at processor reset (power up and power down) - 0.3V to 3.8V 120K - 0.3V to 0.75V 2.3V to 3.6V

Table 3. I/O notations, description and electrical specification

Note 1: Specified parameter relies on specification of subcontractor and is not tested by SenseAir.

Note 2: Do not ground S1 input for a long time. FLASH resource will be exhausted in 3.5 months in case of permanent S1 grounding.

Mechanical properties

Sensor PCB may be colour green or black. Optical bench assembly (OBA) may be colour silver or black.

Please refer to mechanical drawing for detailed specification of dimensions and tolerances.

WARNING!

Under no circumstances should any force be applied to the OBA, this may permanently harm the sensor and most definitely affect performance.

Sensor should be handled holding PCB only. Never touch sensor with bare hands, make sure that operators use ESD gloves.

Note! ESD sensitive device!

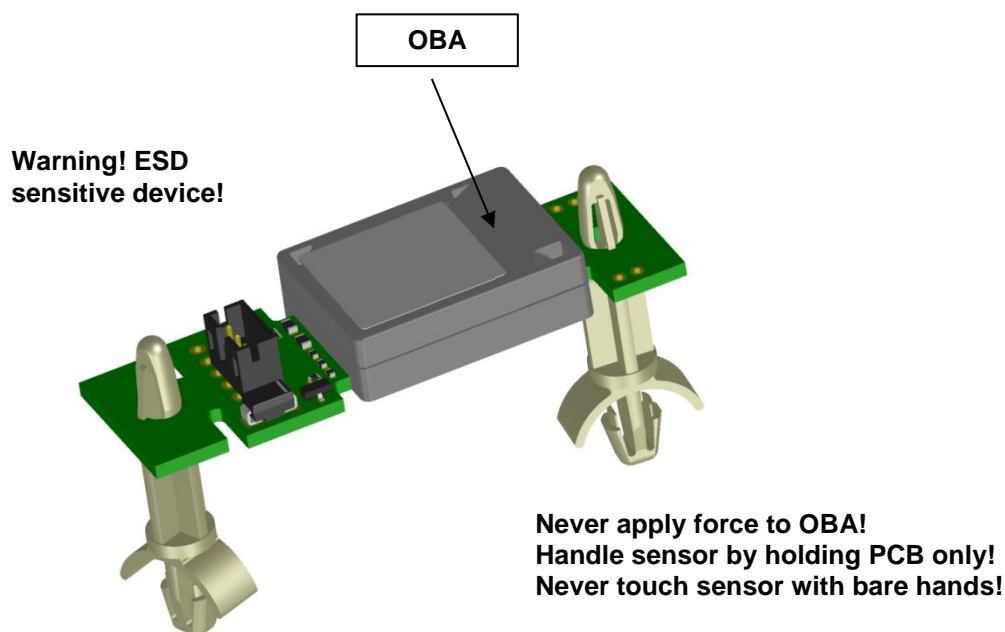

Figure 6. Mechanical properties *SenseAir*[®] S8-4B

Installation and soldering

During installation and assembly of sensor to PCB it is essential that compatible materials are used and that soldering process is managed. Avoid introduction of stress to the sensor's PCB or OBA. SenseAir recommends hand soldering only.

NB! Transport, handling and assembly may affect calibration. If for some reason the sensor needs to be re-calibrated, please refer to paragraph Maintenance.

Please, contact SenseAir for further information!

Maintenance

Calibration switch S1

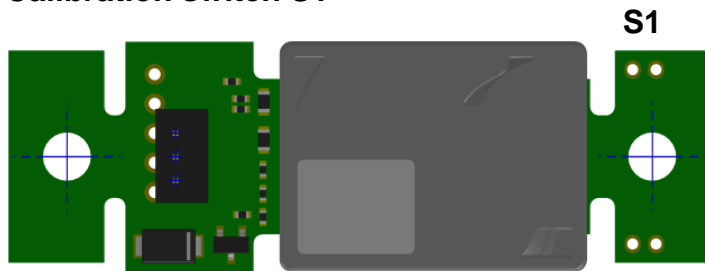

Figure 7. Position of calibration switch S1

If for some reason the sensor needs to be re-calibrated, this is possible to do by a qualified operator, provided that the sensor is exposed to fresh air during the whole process (~400 ppm CO₂).

The process is actuated by creating an electrical short-cut between the two holes labelled S1. As soon as the micro-controller detects this manually shorted switch terminal S1, calibration is restored to fresh air concentration value.

The delay between the shorting of the switch contact S1 and the actual calibration may be up to 30 seconds.

If the operator keeps the sensor with S1 closed for some period of time, the sensor will continue to recalibrate fresh air concentration target value every 30 seconds, until the switch is released.

Alarm test mode

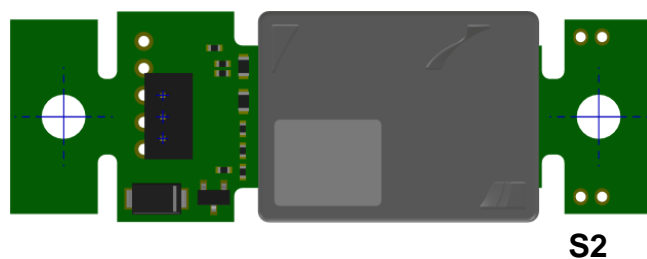

Figure 8. Position of forced output test switch S2

Forced output test switch S2

This function is intended for a qualified operator to check the sensor output and the subsequent system response by simulating sensor alarm.

The process is triggered by putting a short across S2. When the micro-controller detects S2 is shorted the Alarm Output is set.

The delay between shorting S2 and setting of alarm active may be up to 30 seconds.

If S2 remains closed for some period of time, and if sensor is powered, the sensor will hold the output active until the switch closure is released. Delay of up to 30 seconds may occur between switch release and alarm output release.

S8-PGA-4B Output test mode

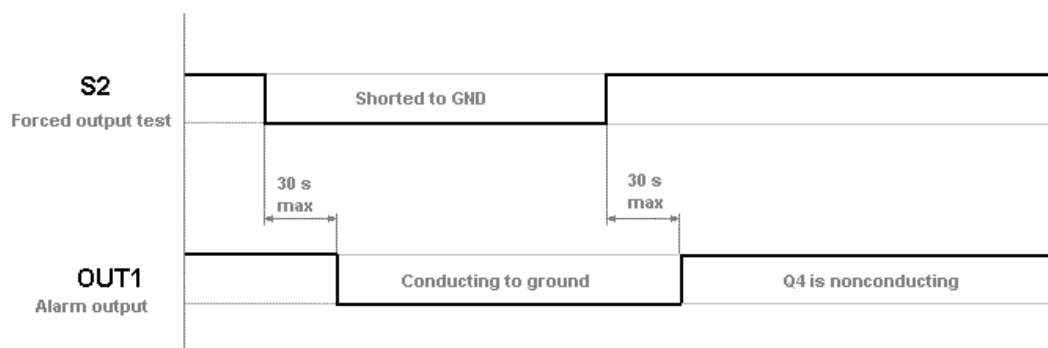
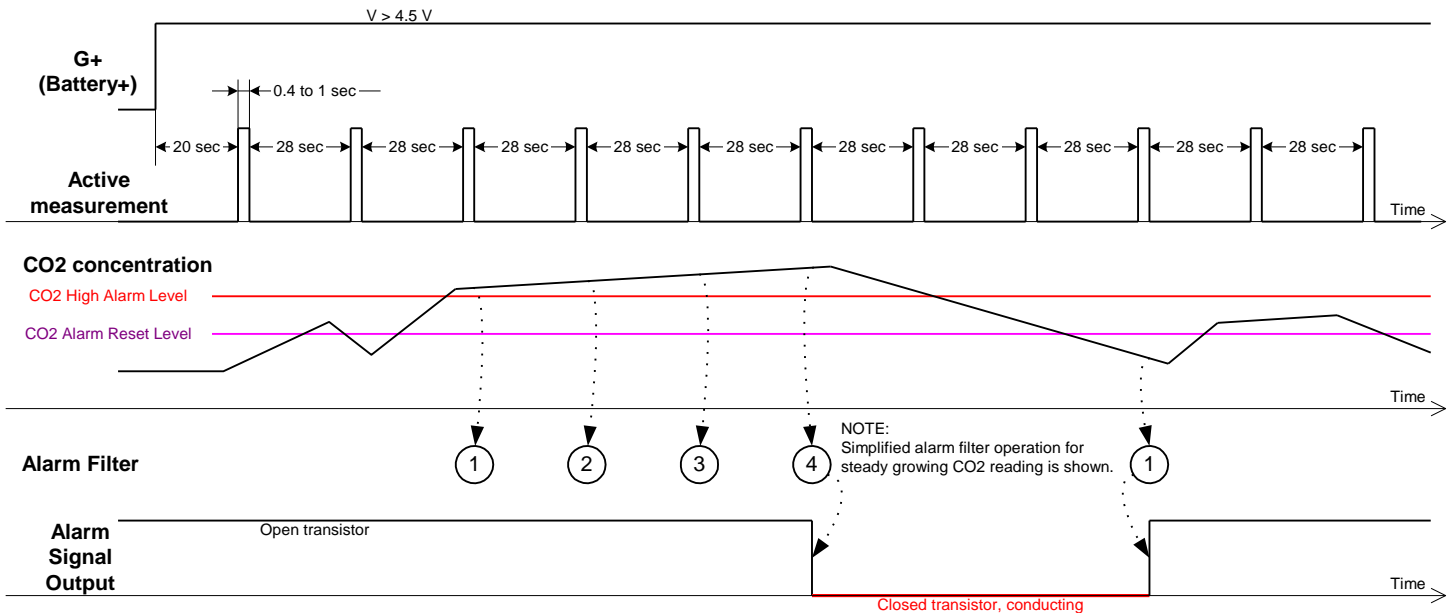

Figure 9. Timing diagram for switch S2

Alarm output filter and time diagram

1. High CO₂ alarm time diagram. (Assume power good).



2. Power Low time diagram. (Assume CO₂ concentration to be under alarm level).

