

# SPECIFICATION FOR APPROVAL

**Customer Name :**

**Customer Item :**

**Part No. :** PR-S188HQ-CR144B-HDT

**Product Description :**

**Draw Date :**

**1.Accessory:**  **Samples**  **Samples Data**

**2.Customer's Proposal :**  **Agree**  **Disagree**

**Reason :**



Rev.	Draw by :	Checked by :	Approved by :
1.2.1	Steven Chen	Gray Huang	Caren
Customer Approve			

**Features**

- 1.6mmx0.8mm SMD LED, 0.55mm thickness
- Welding Plate 0.1mm\*2
- Low power consumption
- Wide view angle
- Package: 4000pcs/reel
- RoHS Compliant



**Package outlines/ Recommend Pad Layout**

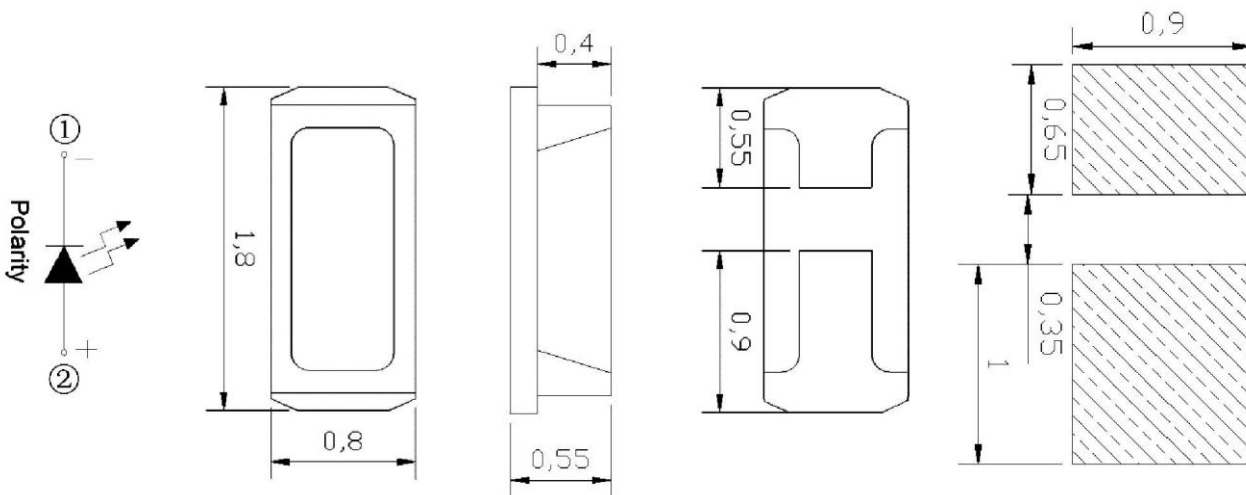

Part No.	Emitted color	Dice	Lens color
PR-S188HQ-CR144B-HDT	Red	AlGaInP	Water transparent

**Notes:**

1. All dimensions are in millimeters (inches);
2. Tolerances are  $\pm 0.1\text{mm}$  (0.004inch) unless otherwise noted.

**Absolute Maximum Ratings (Ta=25°C)**

Parameter	Symbol	Value	Unit
Forward current	If	50	mA
Reverse voltage	Vr	5	V
Power dissipation	Pd	100	mW
Operating temperature	Top	-40 ~+85	°C
ESD(Human-body mode)	--	2	KV
Storage temperature	Tstg	-40 ~+85	°C
Peak pulsing current (1/8 duty f=1kHz)	Ifp	120	mA

**Electro-Optical Characteristics (Ta=25°C)**

Parameter	Test Condition	Symbol	Value			Unit
			Min	Typ	Max	
Wavelength at peak emission	If=50mA	$\lambda_p$	--	660	--	nm
Spectral half bandwidth	If=50mA	$\Delta\lambda$	--	20	--	nm
Dominant wavelength	If=50mA	$\lambda_d$	--	--	--	nm
Forward voltage	If=50mA	Vf	1.8	2.2	2.4	V
Luminous intensity	If=50mA	Iv	--	10	--	Mw/Sr
Viewing angle at 50% Iv	If=50mA	2 $\theta_{1/2}$	--	120	--	Deg
Reverse current	Vr=5V	Ir	--	--	10	$\mu$ A

## Radiation Characteristics

$I_F=50\text{mA}, T_a=25^\circ\text{C}$

Forward Current Vs. Forward Voltage

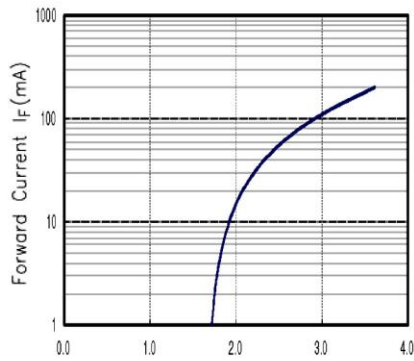

Luminous Intensity Vs. Forward Current

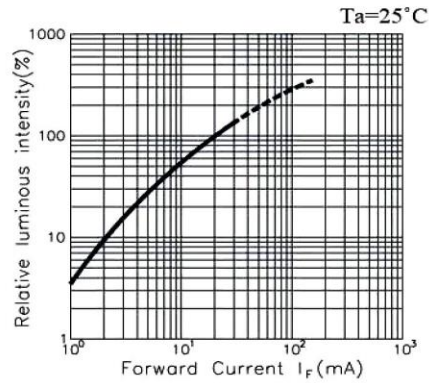

Forward Current Derating Curve

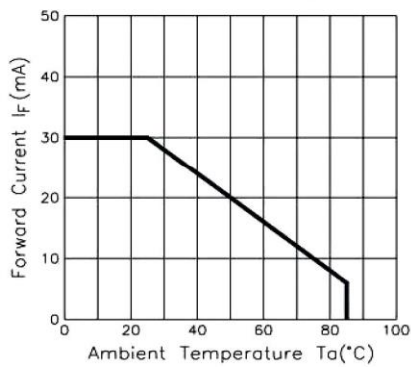

Radiation Diagram

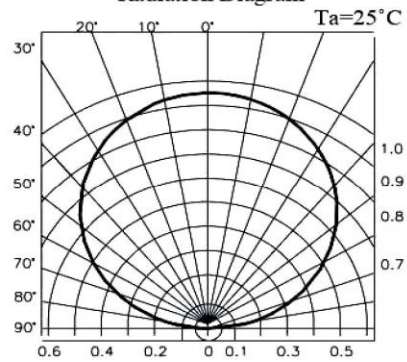

Spectrum Distribution

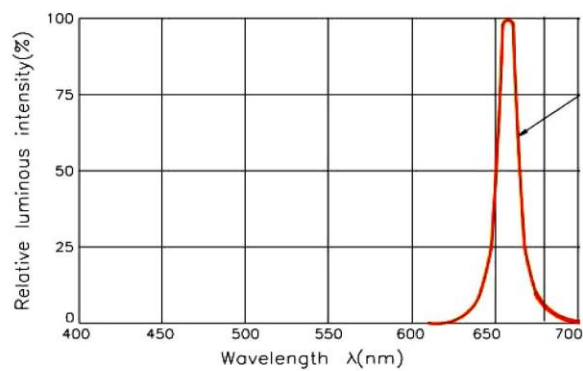

## Reflow Profile

### ■ Reflow Temp/Time

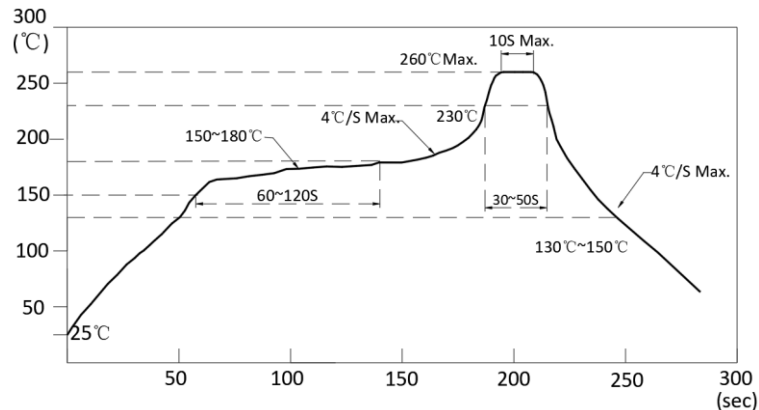

### Notes:

1. We recommend the reflow temperature 245°C (±5°C).
2. The maximum soldering temperature should be limited to 260°C.
3. Don't cause stress to the epoxy resin while it is exposed to high temperature.
4. Number of reflow process shall be 2 times or less.

### ■Soldering iron

Basic spec is  $\frac{6}{\lambda}$  5sec when 320°C (±20°C). If temperature is higher, time should be shorter (+10°C → -1sec).

Power dissipation of iron should be smaller than 20W, and temperatures should be controllable. Surface temperature of the device should be under 350°C.

### ■Rework

1. Customer must finish rework within 5 sec under 340°C.
2. The head of iron cannot touch copper foil
3. Twin-head type is preferred.

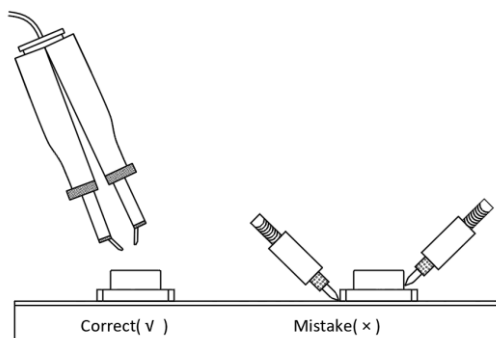

- Avoid rubbing or scraping the resin by any object, during high temperature, for example reflow solder etc.

## Handling precautions

### 1. Drive Method

A LED is a current-operated device. In order to ensure intensity uniformity on multiple LEDs connected in parallel in an application, it is recommended that a current limiting resistor be incorporated in the drive circuit, in series with each LED as shown in Circuit below.

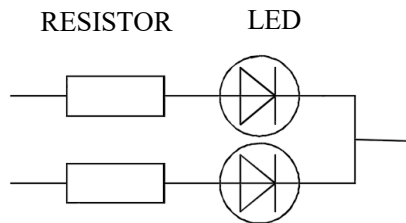

### 2. Storage

2.1 Do not open moisture proof bag before the products are ready to use.

2.2 Before opening the package: The LEDs should be kept at 30°C or less and 60% RH or less.

2.3 After the package is opened, the products should be used within a week or they should be kept to store at  $\leq 20$  R.H. with zip-lock sealed.

### 3. Baking

It is recommended to baking before soldering when the pack is unsealed after 72hrs. The Conditions are as followings:

3.1  $60 \pm 3^\circ\text{C}$  x (12~24hrs) and  $< 5\%$  RH, taped reel type

3.2  $100 \pm 3^\circ\text{C}$  x (45min~1hr), bulk type

3.3  $130 \pm 3^\circ\text{C}$  x (15~30min), bulk type



Max Vantage

Test Items and Results of Reliability

Test Item	Test Conditions	Standard Test Method	Note	Number Of Test
Reflow Soldering	Ta=260±5°C,Time=10±2S	JB/T 10845-2008	3times	0/22
Salt Atmosphere	Ta=35±3°C,PH=6.5 ~ 7.2	GB/T 2423.17-2008	24hrs	0/22
Temperature Cycling	-40±5°C      30±1min ↑→(25°C/5±1min)↓ 100±5°C      30±1min	GB/T 2423.22-2012	100cycles	0/22
Thermal Shock	Ta=-40±5°C ~ 100±5°C, 15±1min dwell	GB/T 2423.22-2012	100cycles	0/22
High Humidity High Temp. Cycling	Ta=30±5°C ~ 65±5°C, 90±5%RH,24hrs/1cycle	GB/T 2423.4-2008	10cycles	0/22
High Humidity High Temp. Storage Life	Ta=85±5°C,ψ(%)=85±5%RH	GB/T 2423.3-2006	1000hrs	0/22
High Temperature Storage Life	Ta=100±5°C,non-operating	GB/T 2423.2-2008	1000hrs	0/22
Low Temperature Storage Life	Ta=-40±5°C,non-operating	GB/T 2423.1-2008	1000hrs	0/22
Life Test	Ta=26±5°C,@20mA, ψ(%)=25%RH ~ 55%RH	--	1000hrs	0/22
High Humidity High Temp. Operating Life	Ta=85±5°C,@20mA, ψ(%)=85%RH	GB/T 2423.3-2006	500hrs	0/22
Low Temperature Operating Life	Ta=-20±5°C,@20mA	GB/T 2423.1-2008	1000hrs	0/22