

MPM4730 Intelligent Pressure Transmitter



Features

- 4mA~20mA DC 2-wire current output
- Digital compensation and non-linearity correction technics
- -10°C ~ 70°C digital wider temperature compensation
- RS485 communication interface or HART communication protocol(optional)
- Netting available
- Full stainless steel construction, compact size, light weight
- Special requirement available
- CE and RoHS certificated
- Intrinsic safe ex-proof version conforming to GB3836.4 ExialIBT6 Ga Regulation; Ex-proof Certificate is issued
- Marine type products accord with CCS classification of sea-going steel ships of the rules "(2015) the requirements, has obtained the type approval

Introduction

MPM4730 pressure transmitter is the highly accurate and stable intelligent pressure transmitter. It uses digital temperature compensation, non-linearity correction technics and the most advanced transmitter production technique, the whole product has compact size, high accuracy, light weight and wider pressure range, can be used for flow pressure precise measurement. The product will instead the 2-wire working 4mA~20mA DC output analog signal.

Specification

Basic range (bar)	-1	1	2	3.5	7	10	20	35	70	100	200	350	600	1000
Overpressure (bar)	-1	1.5	3	5	10	15	30	50	100	150	300	500	900	1100

The min.shrunked available pressure range is 1/5 of basic range;
For the pressure range between min.range and max.range, but not indicated in the above table, we enlarge the above basic pressure range to produce (overpressure unavailable);

Total accuracy ①	±0.075%FS(min.); ±0.15%FS(typ.); ±0.25%FS(max.)
Stability	±0.2%FS/year
Compensation temp. ②	-10°C ~ 70°C
Operation temp.	-30°C ~ 80°C ; -10°C ~ 70°C (Cable); -20°C ~ 60°C (Intrinsic safe)
Storage temp.	-40°C ~ 85°C ; -20°C ~ 85°C (Cable)
Power supply	10V~28V DC(RS485); 12V~30V DC(HART); 10V~12V DC(Intrinsic safe)
Output	4mA~20mA DC RS485/HART(optional)
Load	4mA~20mA DC output; (U-10V)/0.02A(Ω)(RS485); (U-12V)/0.02A(Ω)(HART) RS485 bus line could connect with 99 transmitters
Electrical connection	DIN43650, 4-pin plug(RS485 socket inside) 7-pin plug(for RS485 interface output at local place) Φ7.2mm shielding cable
Insulation	100MΩ/50V
Shock	20g, (20~5000)Hz
Impact	20g,11ms
Protection	IP65(B ₁ , B ₂); IP63(B ₃)
Media compatibility	Diaphragm: SS 316L Housing: SS 304 O-ring: Viton
Weight	~160g
① Total accuracy: including linearity, hysteresis, repeatability and thermal error;	
② For special temperature requirement, please feel free to contact our company.	

Outline Construction (Unit: mm)

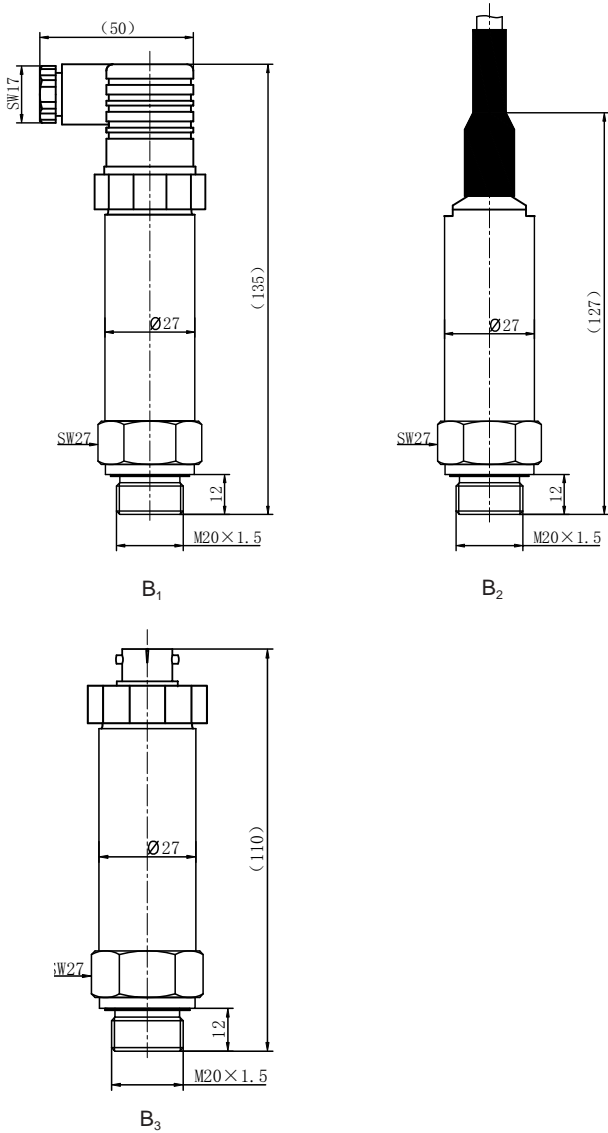

Connector appearance and ordering

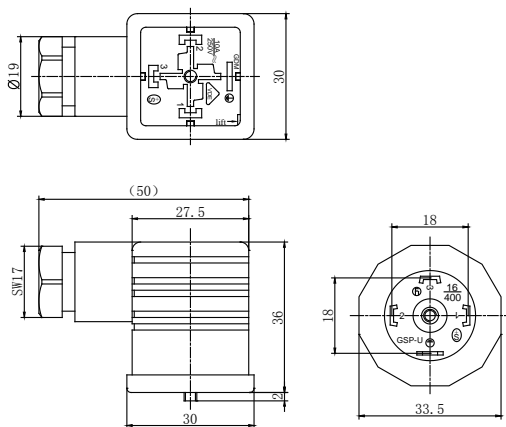

Electrical Connection

Transmitter connecting the air through plug or cable:

Electric connection of non-explosion proof product	Function	Inner plug pin color	Outer plug connection		
			4-pin plug	Cable wire	7-pin plug
	+V	1(Black)	1	Black	1
	+OUT/GND	2(Red)	2	Red	2
	RS485B	4(White)	⊥	White	5
	RS485A	5(Yellow)	3	Yellow (Green)	4

Electric connection of explosion proof product	Function	Inner plug pin color	Outer plug connection		
			4-pin plug	Cable wire	7-pin plug
	+V	1(Black)	1	Black	1
	+OUT/GND	2(Red)	2	Red	2
	Case	3(Blue)	⊥	Blue	7
	RS485B	4(White)	-	White	5
	RS485A	5(Yellow)	-	Yellow (Green)	4

Note: Explosion-proof product of 4-pin plug connection only provide 4mA ~ 20mA DC output

A: Electrical Connection for transmitter with 4mA~20mA DC output

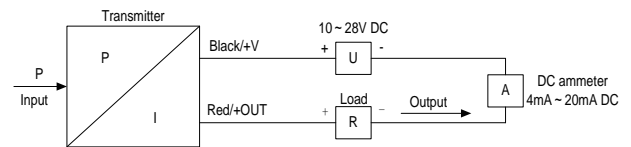

B: Electrical connection for transmitter with RS485 interface

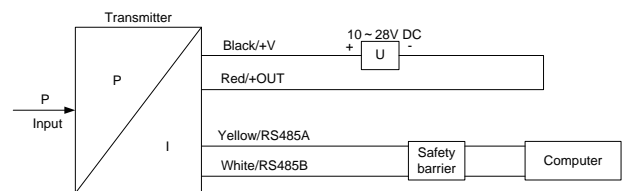

C: This Ann explosion-proof type electrical connection methods are shown below:

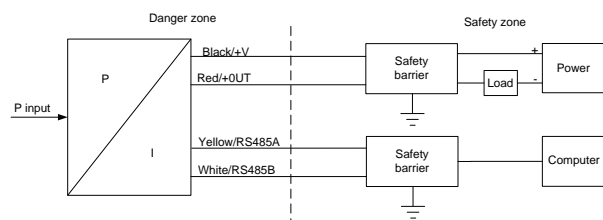

ExialIBT6 Ga

Transmitter Ex-proof parameter:
 Ui: 12.4V DC Ii: 140mA DC
 Li: 0mH Ci: 1.049μF Pi: 0.43W

ExialIC

Safe barrier's ex-proof parameter:
 Uo: 12.4V DC
 Io: 140mA DC Po: 0.43W

D: Wiring for HART® transmitter connecting with hand communicator:

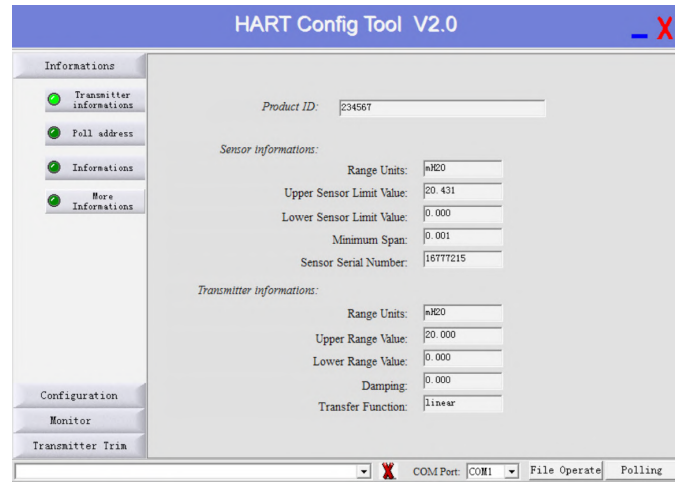
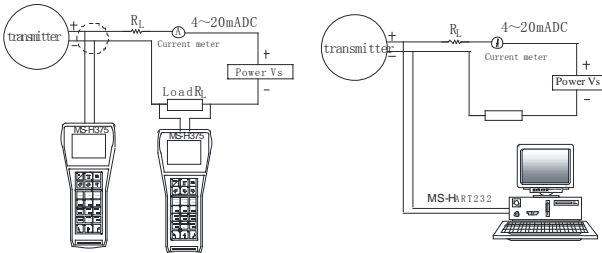

Local Application

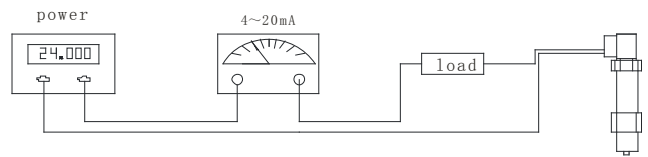

2-wire local pressure measurement

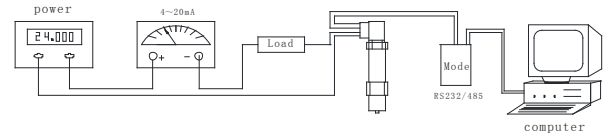

Calibration with computer

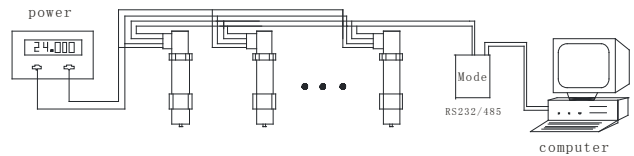

Transmitter with RS485 interface

Assistant Software

A: Transmitter Software for RS485 Interface:

MS Setonline Software

RS232/485 conversion module is used to communicate with RS485 interface, display actual pressure, set new zero, and analog output and transmitter address.

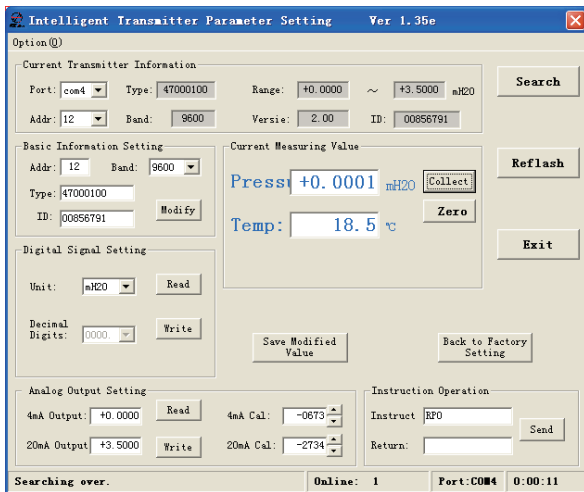

Note: "MS Setonline" software could be downloaded from our website www.microsensor.cn

B: Software for HART® transmitter:MS-C100A software

Through MS-HART232 conversion module, the user could calibrate and adjust HART® transmitter.

Order Guide

MPM4730		Intelligent Pressure Transmitter			
		Range	-1bar...0bar~0.1bar...1000bar		
		[0~X]bar	X: Actual measure range		
		Code	Output signal		
		E	4mA~20mA DC		
		R ₄	RS485 communication interface, ASCII protocol		
		R ₈	RS485 interface, MODBUS communication protocol		
		H	HART [®] communication protocol		
		Code	Construction material		
			Diaphragm	Pressure port	Housing
		22	SS 316L	SS	SS
		24	SS 316L	SS 316L	SS 316L
		Code	Others		
		B ₁	4-pin plug connection		
		B ₂	Cable connection, default cable length: 1.5m		
		B ₃	7-pin plug connection		
		PC ₁	Flush diaphragm, M20×1.5 male		
		PC ₃	Flush diaphragm, G1/2 male		
		C ₁	M20×1.5 male, face type seal		
		C ₃	G1/2 male		
		C ₄	G1/4 female		
		C ₅	M20×1.5 male, waterline seal		
		G	Gauge		
		S	Sealed gauge		
		A	Absolute		
		i	Intrinsic safe version ExialIBT6Ga		
		T	Ship-use		
MPM4730	[0~1]bar	ER ₄	22	B ₃ C ₁ G	the whole spec.

Notes

1. Gauge pressure ≤0.2bar, negative pressure and absolute pressure ≤5bar product accuracy ±0.5%;
2. Flush diaphragm transmitter's pressure range: 0bar~0.7bar...350bar;
3. Output of explosion-proof product: For B₁ connection, only E is optional. For B₂ or B₃ connection, E/R₄/R₈/ER₄/ER₈ are optional;
4. If the user has special requirement, please feel free to contact our company.