

# Earth Resistance Clamp Meter

## USER'S MANUAL

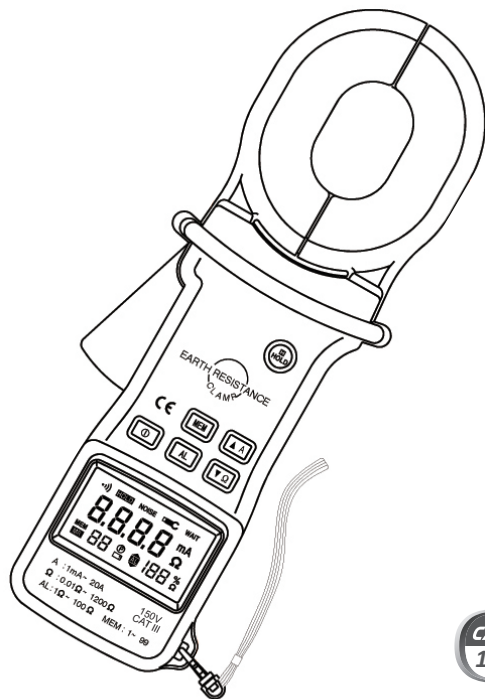

CAT III  
150V

## **Earth Resistance Clamp Meter**

---

### **CONTENTS**

WARNING.....	1
MAINTENANCE.....	1
INTRODUCTION.....	2
FRATURAS.....	2
SUMMARY OF FUNCTION.....	3
LAYOUT.....	3
LCD DISPLAY.....	4
OPERATION	
ON/OFF OPERATION.....	6
EARTH RESISTANCE	
MEASUREMENT.....	7
CURRENT MEASUREMENT.....	10
HOLD BUTTON.....	11

## **Earth Resistance Clamp Meter**

---

### **CONTENTS**

ALARM OPERATION.....	11
MEMORY FUNCTION.....	12
SPECIAL FUNCTION.....	13
SPECIFICATION.....	15
FEATURES.....	15
ACCESSORY.....	16
CHANGING THE BATTERIES.....	16
APPLICATION FIELD.....	18

## Earth Resistance Clamp Meter

---

### Warning

- Before measuring, the metal objects or the conductors that connected with the electric equipment are deadliness danger, earth system is also danger. So when you test the electric equipment, you must especially pay attention to safety.
- Warning letter that chiseled in the back of your instrument reminds you that the values must not be exceeded, the measurement ranges, and briefly, the operation of the clamp.
- Do not exceed the permissible overloads of loop current.
- Before switching the instrument on, you must press the trigger several times to ensure the clamp closing correctly.
- When switch on and the clamp is auto-calibrating, do not open the clamp or hook the clamp jaw around any conductor.

### Read the instructions before using the instrument

#### Maintenance

Keep the surfaces of the clamp jaw clean, any dirt may cause malfunction of the clamp.  
Use the soft damp cloth to clean the clamp jaw faces, do not use abrasives, solvents, alcohol.  
Avoid any shock, especially the clamp jaw faces.  
Avoid the immediate proximity of metallic masses.  
After each measurement, press the HOLD button to depress consume of the batteries.  
Remove the batteries from the instrument in case of prolonged non-use.

## Earth Resistance Clamp Meter

---

### Introduction

Modern industrial electronic equipment is in quick development. A good Earth is becoming an efficient system to prevent from interference and thunderbolt. Safe and quick earth tester is the most needed. Earth resistance clamp is a break through from traditional tester. Neither the supplementary earth leads nor the break earth equipment is necessary. Ground resistance result can be get safely and fast only by clamping the ground line. Additionally, current testing is also provided. High sensitivity clamp meter can measure the leakage current to 1mA, neutral current to 20A RMS. It is especially important for testing ground circuit with strong interference and ripple that will influence the electrical quality. Besides industrial electronic equipment, it is also widely used in the field of electric power distribution, telecommunication and architectural ground.

### Fratures

- 0.01Ω high accuracy for low resistance measurement
- 0.001Ω high resolution
- Record 99 resistance measurement values
- With alarm function of resistance limit, set alarm threshold in 1Ω to 100Ω
- Measure leakage current and neutral current 1mA~20A
- 45mm×32mm large jaws of exactitude measurement probe
- Digital measurement, autorange ,easy operation
- Double insulation, strengthen the interference resistance
- Untouched measurement ,ensure the safety
- Time per measurement : 1 second
- current overload display : ≥20A RMS, display “OL”

## Earth Resistance Clamp Meter

### Summary of function

FUNCTION	BUTTON
ON/OFF/EXIT SET MODE	ⓘ
A MEASUREMENT/ ALARM VALUE INCREASE/ RECORD NUMBER SELECT	▲A
Ω MEASUREMENT/ ALARM VALUE MINISH/ RECORD NUMBER SELECT	▼Ω
HOLD DISPLAY	HOLD
SELECTALARM MODE	AL
SELECT/SET MEMORY MODE	MEM
SWITCH BUZZER ON/OFF	ⓘΩ
SET ALARM VALUE	ⓘAL
AUTO POWER OFF FUNCTION SET	ⓘ+HOLD
READ SAVED MEASUREMENT VALUE	ⓘ+MEM
RESET MEMORY TO ZERO	HOLD+MEM

## Earth Resistance Clamp Meter

### Layout

1. Clamp jaw
2. Trigger
3. MEM Button
4. ⓘButton  
(ON/OFF BUTTON)
5. LCD Display
6. AL Button
7. ▼Ω Button
8. ▲A Button
9. HOLD Button

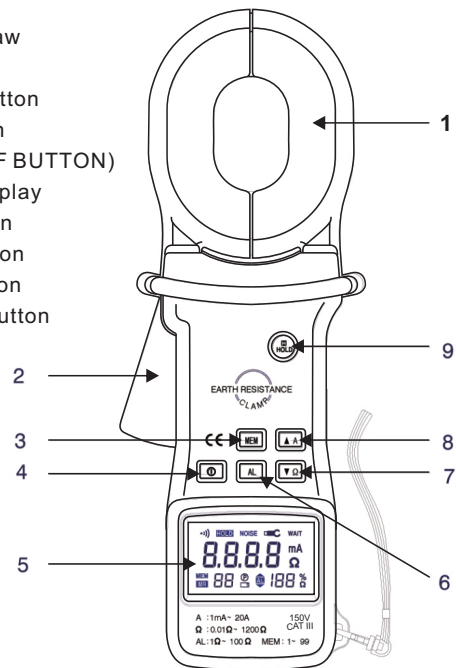

### LCD Display

(Note: when switch on, the clamp performs a rapid auto-test of the whole display. All the symbol on the LCD are display for this short time.)

## Earth Resistance Clamp Meter

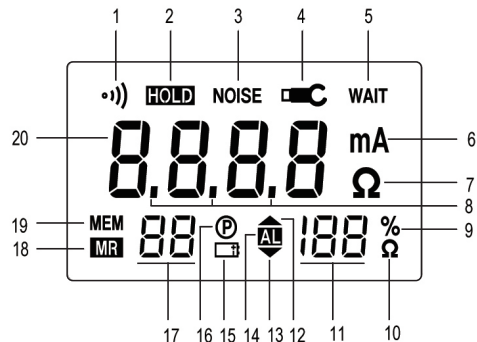

1. Buzzer ON symbol
2. HOLD symbol : hold the last measurement
3. Interference Symbol : showing that the current in the loop is disturbed such that the resistance measurement value is not be guaranteed.
4. Clamp symbol : showing that the clamp is closed incorrectly, can not measure.
5. Wait symbol : showing that the instrument is auto-calibrating
6. Current measurement unit
7. Resistance measurement unit
8. Decimal points
9. Percent sign of the batteries actual service life
10. Alarm threshold value of resistance unit
11. Digital display of the battery actual service life or Alarm threshold value

## Earth Resistance Clamp Meter

12. High Alarm symbol
13. Low Alarm symbol
14. Alarm mode symbol
15. Low voltage indication symbol
16. Auto Power Off symbol
17. Record number symbol
18. Read memory mode symbol
19. save in memory mode symbol
20. 4 digit LCD digital display

### Operation

#### 1. ON/OFF Operation

① button switches ON/OFF. Press ① button so the clamp switch on, Press the ① button for 2 seconds, the instrument switch off.

As soon as it switch on, the earth resistance clamp begins to auto-calibrate to obtain better resolution. When it is calibrating, the instrument will count from CAL 9 to CAL 0. The user must wait for the clamp completed calibration. Do not open the clamp or hook the clamp jaw around the conductor or the object be measured in case of the calibration. After the calibration completed, the instrument returns the measurement mode when last switch off. If the instrument is in resistance measurement mode when switch off, the LCD will display the primary resistance measured value.

## Earth Resistance Clamp Meter

### 2. Earth resistance measurement

1. After switching on, the instrument is automatic in measurement current mode, you can press the  $\nabla\Omega$  button to configure for resistance measurement mode.
2. Hook the clamp jaw around earth leads or electrode to be tested.
3. If symbol " - - - " and  $\blacksquare$  symbol are shown on the display, it indicates that the clamp is closed incompletely. You must press the trigger of the instrument several times to close the clamp jaw correctly. After the  $\blacksquare$  symbol disappears from the display, then it is in the normal measurement mode.
4. Read the measurement value on the display.
5. When the display appears the "NOISE" symbol, it indicates that there is an interference current in the loop, the resistance measurement is not assured.
6. Schematic of measurement

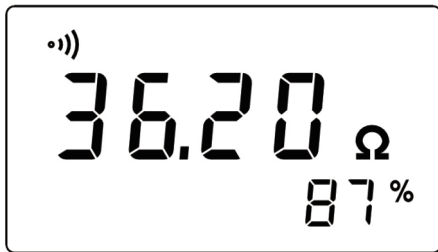

- Buzzer ON
- A loop earth resistance of 36.2Ω
- The batteries service life is 87%

## Earth Resistance Clamp Meter

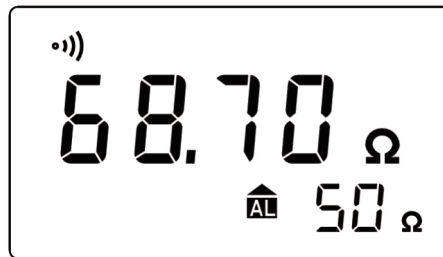

- Buzzer ON
- A loop earth resistance of 68.7Ω
- The earth resistance value is above the high alarm threshold 50Ω, a beep is emitted

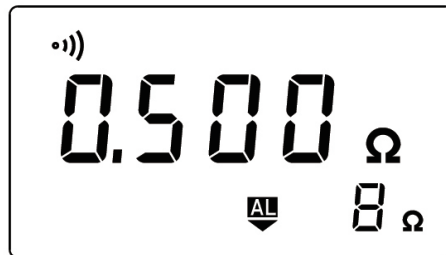

- Buzzer ON
- A loop earth resistance of 0.5Ω
- The earth resistance value is less than the low alarm threshold value 8Ω, a beep is emitted

## Earth Resistance Clamp Meter

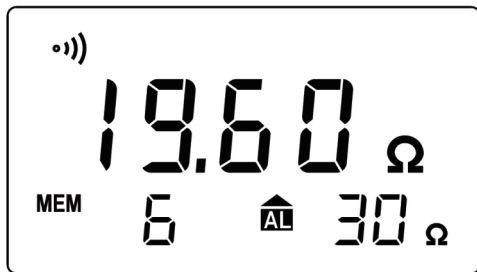

- Buzzer ON
- A loop earth resistance of 19.6Ω
- The earth resistance value is less than the high alarm threshold value 30Ω, no beep is emitted
- 6 recorded values in the memory

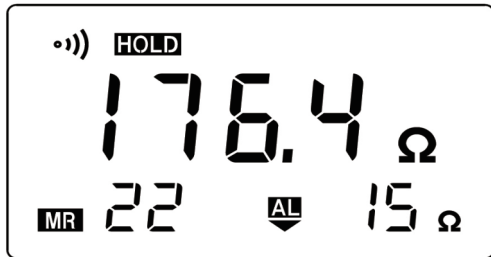

- Buzzer ON
- Read the 22th recorded measurement, the loop earth resistance of 176.4Ω
- The low alarm threshold of earth resistance set at 15Ω

## Earth Resistance Clamp Meter

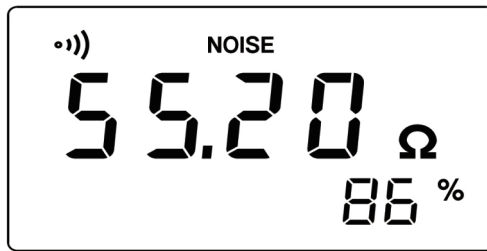

- Buzzer ON
- A interfered current is in the loop resistance, the current measured resistance is 55.2Ω, the value is not guaranteed
- The batteries service life is 86%

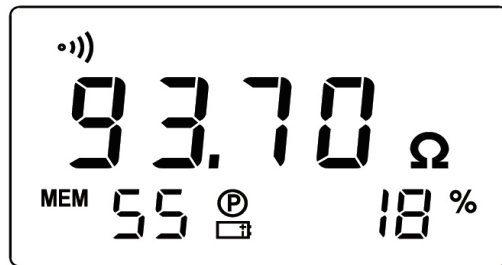

- Buzzer ON
- A loop earth resistance of 93.7Ω
- The batteries service life is 18% and less than 20%.The display appears the low voltage indication
- Auto Power Off function is valid
- 55 recorded values in the memory

## Earth Resistance Clamp Meter

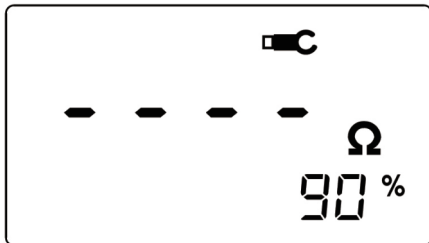

- The clamp jaw is closed incorrectly, "----" is displayed
- The batteries service life is 90%

### 3. Current measurement

1. Press the A button on the instrument.
2. The display shows the current unit "A" or "mA", the instrument is in current measurement mode. You can measure current of the conductor.
3. Read the measurement value on the display.
4. If the display shows symbol "OL", it indicates the measured value exceeds the measurement range.

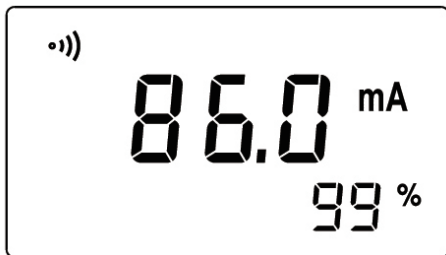







## Earth Resistance Clamp Meter

### 4. Hold button

Press the HOLD button to lock display of the current measure state and last measurement on measurement mode.

### 5. Alarm operation

1. On resistance measurement, press the AL button, "AL" symbol and the value of the alarm threshold are displayed.
2. According to the measurement demand, you can press "AL" button time after time to select one of three alarm modes:
  - LOW ALARM MODE: when signals measurement below the alarm threshold, a continuous beep at low frequency. The  symbol is displayed.
  - HIGH ALARM MODE: when signals measurement below the alarm threshold, a continuous beep at high frequency. The  symbol is displayed.
  - NO ALARM MODE: signals measurement is not confined in alarm threshold .
3. Set the alarm threshold

The earth resistance clamp set initial Alarm threshold value is high alarm threshold of 20Ω. In resistance measurement mode, press the  +AL to set in Alarm threshold value setting mode, then "AL" symbol and the Alarm threshold value are displayed; press  A or  Ω button, you can increase or decrease the Alarm threshold value, the Alarm threshold is from 1 to 100Ω inclusive. After switching off the threshold value is not changed. Setting Alarm threshold value completed, you can press AL button to select one of the three Alarm mode: HIGH ALARM MODE, LOW ALARM MODE, NO ALARM MODE, when the selection is completed, you can press the  button to exit Alarm threshold value setting mode.



## Earth Resistance Clamp Meter

---

### 6. Memory function

1. Clear memory  
Press the HOLD+MEM for 3 seconds, then the "CLR" symbol is shown on the display. At a beep, the memory is cleared. The instrument return to measurement mode automatically.
2. Save measured value  
When press the MEM button,the "MEM" symbol is displayed; press this button for 2 seconds to save the current measured value in memory.The number of record goes up by 1 automatically and is shown on the display, when the number of the record is 99, if MEM button is pressed again at this time, a beep is emitted and the instrument prohibits saving the measurement value. When the batteries service life is less than 20%, a beep warns that the saving measured value is prohibited.
3. Read the saving measurements  
Press the  $\text{H}$ +MEM for 1 second, then the instrument is in the read memory mode, the "MR" and "HOLD" symbo are displayed, the number of the record and the measured value are shown at one time. To display previous record or subsequent record in the memory press  $\blacktriangle$  A button or  $\blacktriangledown$   $\Omega$  button. You can press the  $\text{H}$  button to exit read the record mode to return resistance measurement mode.

### 7. Special function

1. Press  $\text{H}$  + $\Omega$  button, the  $\text{H}$  buzzer symbol disappears from the display, the buzzer be switched off and beep function of pressing button or Alarm function is invalid; press the  $\text{H}$  + $\Omega$  to switch on the buzzer again.
2. ON/OFF Auto Power Off function  
Press  $\text{H}$  +HOLD button, the LCD display "P" symbol, the Auto Power Off function switch on. After no operation for 5 minutes, the instrument switch off automatically. Press  $\text{H}$  +HOLD again, then the "P" symbol disappears from the display, the Auto Power Off function switch off.

## Earth Resistance Clamp Meter

---

To switch off the instrument press the  $\text{H}$  button for 2 seconds.

3.  $\text{H}$  Symbol  
When the battery service life is less than 20%,the symbol is continual displayed, the clamp can not save the measured value in memory in this case. When the batteries service life is less than 15%, prompt beeps is continual emitted. After 10 beeps is emitted, the instrument switch off automatically.
4. NOISE Symbol  
"NOISE" appears on the display indicate that an interference current of testing earth resistance is too high, the resistance measurement is not accurate.
5.  $\text{H}$  Symbol  
This symbol indicates that the clamp is close incorrectly and can not make a measurement.
6. WAIT Symbol  
This symbol is shown on the display when the instrument switch on and begin to auto-calibrate., it is from CAL 9 to CAL 1 to calibration count.
7. OL Symbol  
Measured resistance value exceeds 1200 $\Omega$ or measured current value exceeds 20A, this symbol is shown on the display.

## Earth Resistance Clamp Meter

### Specification

	RANGE	ACCURACY	RESOLUTION
	0.01Ω~0.999Ω	±(1.5%+0.01Ω)	0.001Ω
	1Ω~9.99Ω	±(1.5%+0.3Ω)	0.01Ω
RESISTANCE	10Ω~99.9Ω	±(3.0%+0.3Ω)	0.1Ω
	100Ω~199.9Ω	±(5.0%+3Ω)	1Ω
	200Ω~400Ω	±(6.0%+5Ω)	5Ω
	400Ω~500Ω	±(10%+10Ω)	10Ω
	500Ω~1200Ω	approx. 20%	20Ω
	100mA	±(2.5%+1mA)	0.1mA
	300mA	±(2.5%+2mA)	0.3mA
CURRENT	1A	±(2.5%+0.003A)	0.001A
	3A	±(2.5%+0.01A)	0.003A
	10A	±(2.5%+0.03A)	0.01A
	20A	±(2.5%+0.05A)	0.03A

#### ※ TESTING CONDITIONS:

Temperature	23°C±3°C
Humidity	50%RH±10%
Battery Voltage	> 7V
External magnetic field	< 40A/m
External electric field	< 1 V/m
Testing frequency of current	45Hz~65Hz

### Features

- Test voltage : 3700V
- Electric clearance : 6.5mm ( EN 61010-1 double insulation  CAT III 150V )

## Earth Resistance Clamp Meter

- Electric shock : EN 61010-1
- Limiting overload : 20A RMS current
- Average consumption : approx. 50mA
- Range : autorange
- Display : LCD 4 digits, 9999
- Low voltage indication : display  symbol
- Power supply : 2x9V ALKALINE Battery
- Average service life: recharge 500 times, per time approx. 10~12 hours for continuum using
- Time per measurement : 1 SECOND
- Operate temperature : -10°C~50°C(14°F to 122°F)
- Store temperature : -20°C~60°C(-4°F to 140°F)
- Conductor size : Φ32mm OR 45mm×32mm
- Dimensions : 54mm×104mm×276mm
- Weight : approximate 1050g (include the batteries)

### Accessory

Calibration loop of resistance (5Ω)	1 piece
Calibration loop of resistance (1Ω)	1 piece
Calibration loop of resistance (10Ω)	1 piece
9V ALKALINE Battery	2 piece
Users manual	1 piece
Carry case	1 piece

### Changing the batteries

When the display appears the  symbol , the batteries is weak , they must be changed. Please follow these steps:

## Earth Resistance Clamp Meter

1. Switch off
2. Unscrew the screw on the battery cover
3. Remove the cover
4. Take the battery box out of the instrument
5. Replace new batteries of the same type
7. Reinstall the battery box
8. Replace the battery cover
9. Reinstall the screw

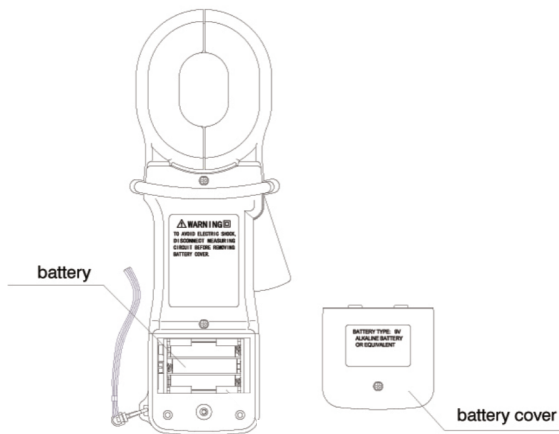

## Earth Resistance Clamp Meter

### Application field

EARTH RESISTANCE CLAMP is designed for testing earth resistance of any loop system, for example not only earth resistance of electric power transportation conductors and communication circuitry, but also earth resistance of electric equipment and lightning arrester can be tested. When there is a interference current in the grounding loop, the accuracy of resistance measurement is affected, the interference current can be tested by the earth resistance clamp.

### Principle of measurement

$R_x$  : earth resistance value to be tested

$R_1 R_2 \dots R_n$ : multiple parallel earth resistance

$R_{earth}$ : normally be regard as  $0\Omega$

$R_{guard\ wire}$  : normally be regard as  $0\Omega$

$R_{Loop} = R_x + R_{earth} + (R_1 // R_2 // \dots R_n) + R_{guard\ wire}$

When  $R_1 // R_2 // \dots R_n \ll R_x$ , then  $R_{Loop} = R_x$

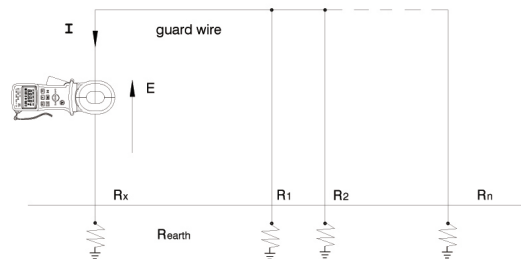

## Earth Resistance Clamp Meter

### 1. Testing earth resistance of electric power

#### 1.) Testing Earth Resistance Of Distribution Circuitry

Usually most electrodes of neutral wire are connected in parallel for three-phase, four-wire system. The resistance is very low, so you only hook the clamp around earth conductor to be measured to test the distribution circuitry. Other earth electrodes become supplementary electrode naturally.

#### 2.) Testing Transmit Electricity Circuitry (Iron Tower)

Transmit electricity circuitry works by iron tower. The earth system of iron tower connect with lightning rod of iron tower, so iron tower that needn't tested becomes very well supplementary electrode. This is a great progress that is breakthrough from traditional tester which threw into supplementary electrode on the road.

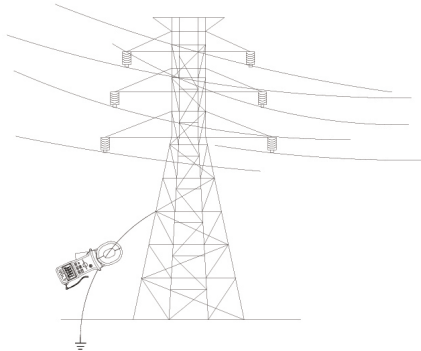

## Earth Resistance Clamp Meter

### 2. Electric power maintain of the factory

Usually the factory is divide into several different earth network fields, so you can test earth resistance in this way:

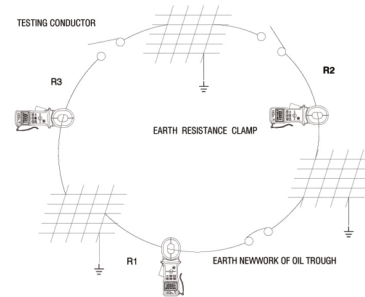

### 3. Testing earth resistance of telecommunication insulates the cables

To testing the shield lay which avoid circuit be interfered, the earth resistance clamp can measure earth resistance by directly and simply.

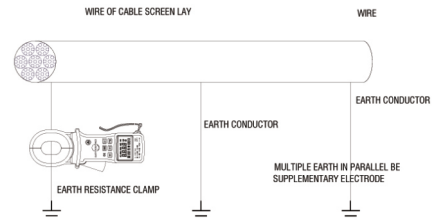

## Earth Resistance Clamp Meter

### 4. Application of faraday-cage protect system

Using FARADAY-CAGE to avoid instruments and equipment be static interfered, so it is very important that we can control earth resistance. If the user want to test earth resistance value of each electrode, it is no necessary set supplementary electrode and the user can test referring the follow diagram. If the user want to test integrate earth resistance of all FARADAY-CAGE, you can make measurements by low value earth electrode being supplementary electrode.

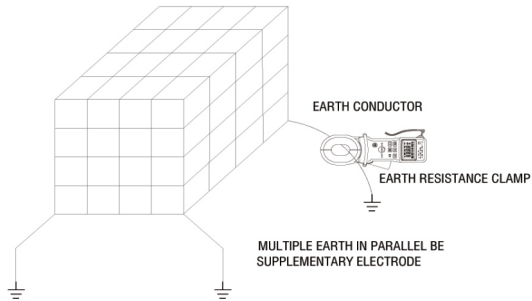

### 5. Testing earth resistance of oil trough

The oil trough often has over two earth electrode . **Note:** When the oil trough has itself earth conductor, it very becomes short circuit, the user can make measurement by other oil trough being supplementary electrode.

## Earth Resistance Clamp Meter

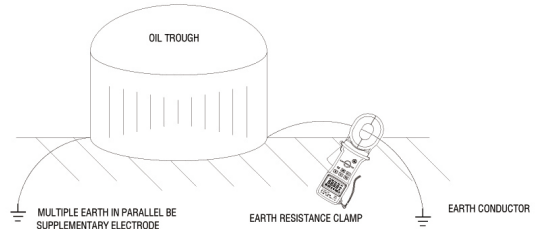

### 6. Testing earth resistance of lightning rod

When lightning rod only use one earth conductor and earth electrode, you can apply other earth object being supplementary electrode to form a loop.

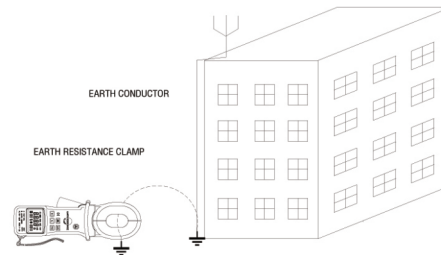

When lightning rod has over two earth conductors, you can make measurement as follow diagram. The resistive value measured in this way is a sum for local earth in series and resistance of earth conductors.(when resistance of earth conductors is very low, it can be ignored.)

# Earth Resistance Clamp Meter

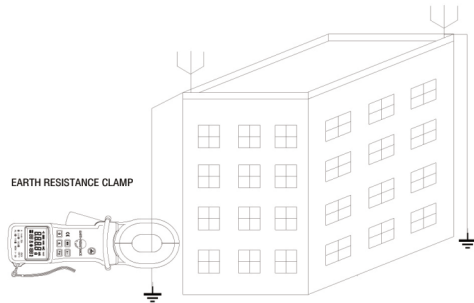

## 7. Application of gas station

For gas station it is necessary that testing earth resistance to prevent static electricity. Apply earth electrode of oil trough to be supplementary electrode to test earth resistance of gas station. That the tested result is maybe sum for earth resistance of gas station and earth resistance of oil trough in series is noticeable.

