

# SP-15A

## FIS GAS SENSOR SP-15A for LP-GAS (PROPANE/BUTANE) DETECTION

The SP-15A is a tin dioxide semiconductor gas sensor which has a high sensitivity and excellent selectivity in propane/butane detection. The SP-15A has also a significant feature in good stability after exposure to silicone compounds. Using the SP-15A, the most reliable LP-Gas leak detection can be achieved.

### Structure

Gas sensitive semiconductor material is formed on the alumina substrate on which the gold electrodes are printed. A thick film heater of ruthenium oxide is printed on the reverse of the substrate and placed in the plastic housing (Fig 1).

### Operating conditions

Fig 2 shows the standard operating circuit for this model. The change of the sensor resistance ( $R_S$ ) is obtained as the change of the output voltage across the fixed or variable resistor ( $R_L$ ). In order to obtain the best performance and specified characteristics, the values of the heater voltage ( $V_H$ ), circuit voltage ( $V_C$ ) and load resistance ( $R_L$ ) must be within the range of values given in the standard operating conditions shown in the Specification table on the next page.

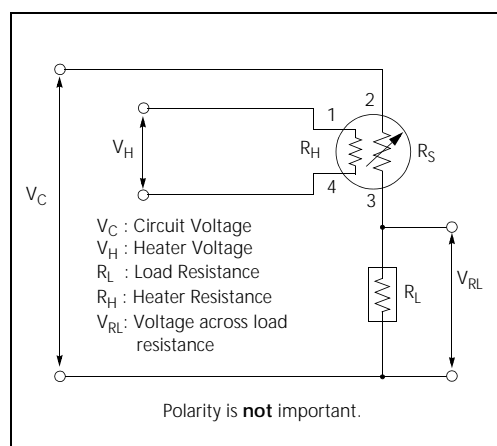

Fig 2. Standard circuit

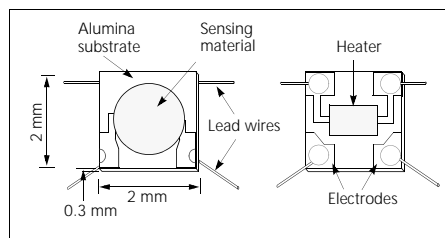

Fig 1a. Sensing element

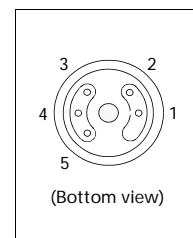

Fig 1c. Pin Layout

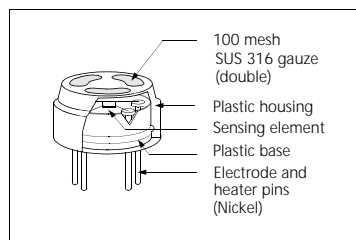

Fig 1b. Configuration

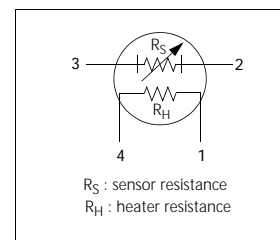

Fig 1d. Equivalent circuit

### Sensitivity characteristics

Fig 3 shows the sensitivity characteristics curves of the SP-15A (typical data). Sensitivity characteristics of the FIS gas sensors are expressed by the relationship between the sensor resistance and gas concentration. The sensor resistance decreases with an increase of gas concentration based on a logarithmic function.

The sensitivity performance of the SP-15A is specified by the following parameters.

- Sensor resistance level: at iso-butane 1500 ppm
- Sensor resistance change ratio: between iso-butane 1500 ppm and 3000 ppm

See the specification table on the next page for further details.

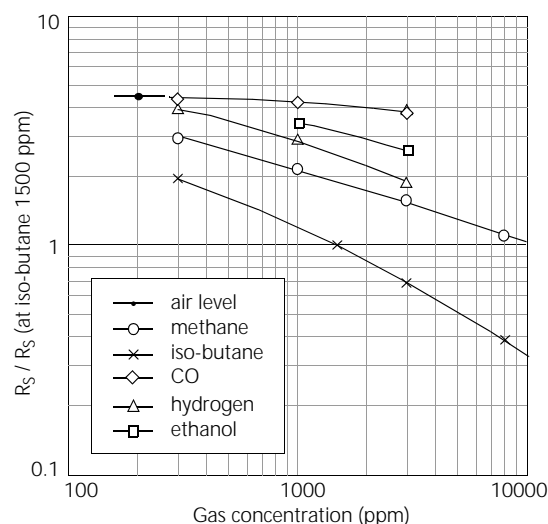

Fig 3. Sensitivity characteristics

### SPECIFICATIONS

SP-15A

## Specifications

### A. Standard Operating conditions

Symbol	Parameter	Specification	Conditions etc.
$V_H$	Heater voltage	$5.0\text{ V} \pm 4\%$	AC or DC
$V_C$	Circuit voltage	$5.0\text{ V} \pm 4\%$	AC or DC
$R_L$	Load resistance	Variable	$P_S < 15\text{ mW}$
$R_H$	Heater resistance	$42\ \Omega \pm 2\ \Omega$	at room temperature
$P_H$	Heater power consumption	380 mW (Typical value)	$P_H = V_H^2 / R_H$
$P_S$	Power dissipation of sensing element	Less than 15 mW	$P_S = \frac{(V_C - V_{RL})^2}{R_S}$

### B. Environmental conditions

Symbol	Parameter	Specification	Conditions etc.
$T_{ao}$	Operating temperature	$-10\text{ }^\circ\text{C}$ to $60\text{ }^\circ\text{C}$	Recommended range
$T_{as}$	Storage temp	$-20\text{ }^\circ\text{C}$ to $70\text{ }^\circ\text{C}$	
RH	Relative humidity	Less than 95% RH	
$(O_2)$	Oxygen concentration	$21\% \pm 1\%$ (Standard condition)	Absolute minimum level: more than 18%
		The sensitivity characteristics are influenced by the variation in oxygen concentration.	

### C. Sensitivity characteristics

Model	SP-15A-00		
Symbol	Parameter	Specification	Conditions etc.
$R_S$	Sensor resistance	4 k $\Omega$ to 15 k $\Omega$	at 1500 ppm of iso-butane/air
$\beta$	Sensitivity slope	0.60 to 0.75	$\frac{R_S \text{ at IB 3000 ppm}}{R_S \text{ at IB 1500 ppm}}$
Standard Test Conditions: Temp: $20\text{ }^\circ\text{C} \pm 2\text{ }^\circ\text{C}$ $V_C$ : $5.0\text{ V} \pm 1\%$ Humidity: $65\% \pm 5\%$ $V_H$ : $5.0\text{ V} \pm 1\%$ (in clean air) $R_L$ : $10\text{ k}\Omega \pm 5\%$ Pre-heating time: more than 48 hours			

### D. Mechanical characteristics

Items	Conditions	Specifications
Vibration	Frequency: 100 cpm	Should satisfy the specifications shown in the sensitivity characteristics.
	Vertical amplitude: 4 mm	
	Duration: 1 hour	
Shock	Acceleration: 100 G	
	Number of impacts: 5 times	

### Dimensions

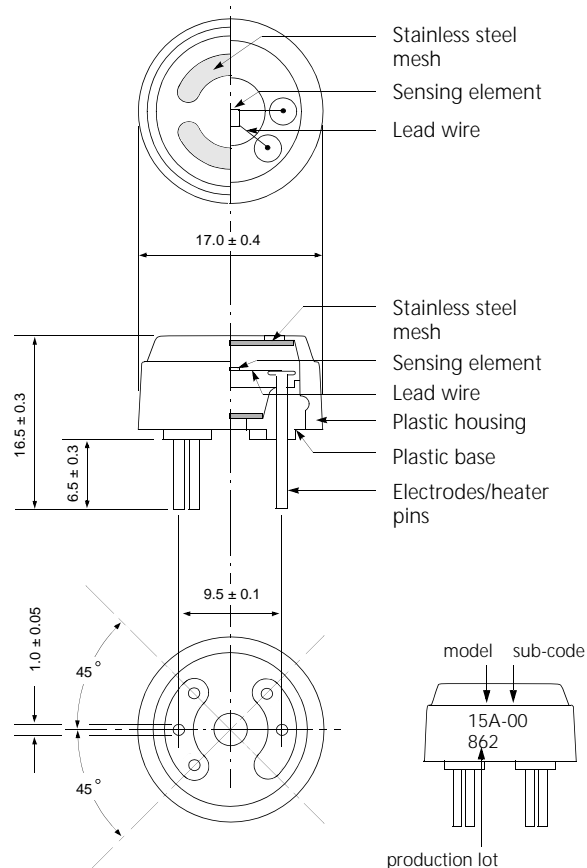

### E. Parts and Materials

No.	Parts	Materials
1	Sensing element	Tin dioxide ( $\text{SnO}_2$ )
2	Substrate	Alumina ( $\text{Al}_2\text{O}_3$ )
3	Lead wire	Noble metal alloy (Au-Pd-Mo)
4	Heater	Ruthenium oxide ( $\text{RuO}_2$ )
5	Electrode	Gold (Au)
6	Plastic housing	Nylon 46 (UL94HB)
7	Plastic base	Nylon 66 (UL94HB)
8	Stainless steel mesh	SUS 316 (100 mesh, double)
9	Heater/electrode pins	Nickel

Please contact

March 2006