



MF5000 Series

# **MEMS Mass Flow Meters**

SIARGO MEMS FLOW SENSING PRODUCTS

## **User Manual (vC.1)**

## RESTRICTION ON USE

---

1. This meter is manufactured for general purpose industrial applications for flow measurements. Do not alter any hardware and software of the product. Any modifications might cause damage and unexpected events.
2. All practices for electronic device safety should apply.
3. Do not use this product in any environments where human safety may be at risk.
4. Only a qualified person from Siargo or a person who is accredited by Siargo can perform troubleshooting services to the product, Siargo is otherwise not liable for any consequences thereafter.

## SAFETY PRECAUTION

---

1. The product can be utilized to measure and/or monitor in-line mass flow rate of any clean, dry and preferably constant concentration gases in industrial applications. For other special gases or variable concentration gases, the product may not function properly or even can be damaged. Please contact Siargo for further information.
2. The operational environments of the product are illustrated in the section of product specifications. If the product is used for other circumstances, the product may not function properly or even can be damaged.
3. Operation, installation, storage, and maintenance of the product must strictly follow the instructions illustrated in this user manual. Otherwise, unpredicted damage and even injuries or other severe situations could be induced. All the installation, storage, and maintenance of the product must be performed by skilled workers. This user manual should be placed near the product for easy access.
4. Before using the product, the user should read this user manual completely and in details so that the user is well understand all the important instructions.  
It is recommended that the product should be re - calibrated and serviced in every two years or at a time of desire.

## Contents

---

RESTRICTION ON USE .....	1
SAFETY PRECAUTION .....	1
Contents .....	2
1 Overview .....	3
2 Models and Selection .....	4
3 Product Description .....	4
4 Specifications .....	5
5 Installation .....	5
5.1 Physical Dimensions .....	5
5.2 Installation Instructions .....	6
5.3 Attentions .....	7
6 Operation and Communication .....	8
6.1 Cable Definition .....	8
6.2 LCD Display .....	8
6.3 RS485 Communication .....	8
6.4 4~20mA Output .....	8
6.5 Pulse Output .....	8
6.6 Setup via Buttons .....	9
7 Safety and Maintenance .....	12
7.1 Wetted Materials and Compatibility .....	12
7.2 Safety Precautions .....	12
7.3 Maintenance .....	12
8 Warranty .....	13
9 Customer Service and Order information .....	14

## 1. Overview

MF5000 series mass flow meters are specially designed for small pipe flow monitoring and control. The series can measure gas flow in a pipe diameter as small as 3 mm, but not over 19 mm. With the self-flow conditioning feature of the MEMS sensor package, the meters feature an extremely low pressure loss compared to the traditional by-pass thermal mass flow meters in this application scope. The accuracy of the meters are generally  $\pm(1.5+0.5FS)\%$  or better depending on the requests. The meters can work at an environment of -20 to 60 C and pressure up to 1.5 MPa. Applications include semiconductor gas process monitoring and control, hospital oxygen gas monitoring, etc.

MF5000 Series MEMS Mass Flow Meters feature:

- ◆ Highly sensitive, measuring as low as 8 mm/sec, and as high as 65 m/sec with a single assembly
- ◆ Directly sense mass flow using thermal mass flow principle
- ◆ Proprietary MEMS sensor package design for better reliability
- ◆ Standard 12 ~ 24 Vdc power supply
- ◆ Low pressure loss for reducing energy cost
- ◆ Industrial standard Modbus protocol for easy networking and remote control

### Working Principle and Package

The MEMS calorimetric sensor is installed at the flow channel wall forming a plate that serves as an additional flow conditioner from the boundary layer configuration resulting in a laminar flow. The mass flow measurement is established as the fluid carries heat away from the heater causing the redistribution of the temperature field. Accurate flow rate is obtained by calibration with the standard fluid at the preset conditions.

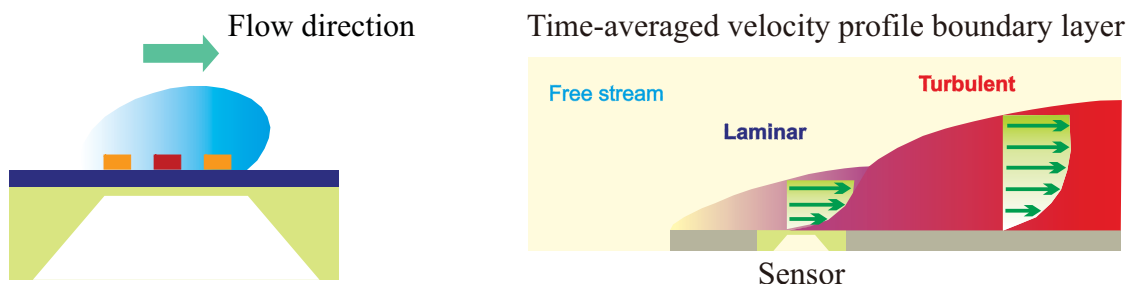

## 2. Models and Selection

In addition to the models listed, we can also provide customized products that will be tailored to customers' very needs. For further information, please contact manufacturer. The meters are made by referencing to: ISO14511.

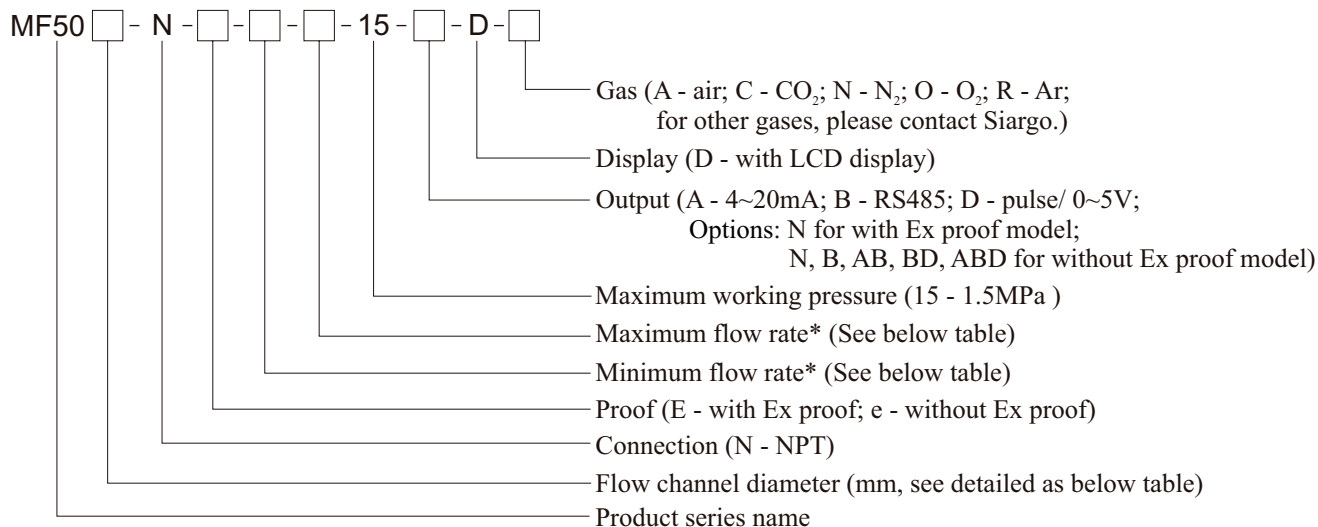

\* There is flow rate number only for unit SLPM. If other unit is selected, there must be flow rate number with unit together.

Typical flow range:

Model	DN (mm)	Connection	Flow range*			
			sccm	SLPM	SCFM	NCMH
MF5003	3	1/8"	150-15000	0.15-15		
MF5006	6	1/4"		0.5-50	0.02-2	0.03-3
MF5008	8	3/8"		1.2-120	0.042-4.2	0.072-7.2
MF5012	12	1/2"		3-300	0.1-10	0.18-18
MF5019	19	3/4"		8-800	0.28-28	0.48-48

\* For CO<sub>2</sub>, flow range are 0.15~10, 0.5~40, 1.2~80, 3~200 and 8~600 SLPM.

## 3. Product description

The parts are illustrated as below:



## 4. Specifications

Accuracy	$\pm (1.5+0.5FS)\%$ ;
Working Temperature	-20~65°C;
Working Pressure	<1.5 MPa;
Humidity	$\leq 95\%RH$ ;
Power supply	12~24 VDC, 50mA;
Interface	4~20mA/RS485/Pulse
Mechanical Connection	NPT;
Display	Mass flow, accumulated mass flow;
Calibration	Air@20°C, 101.325 kPa ( other gases upon request);
Ex Proof	Ex ia IIC T4
Protection	IP40

## 5. Installation

### 5.1 Physical Dimensions

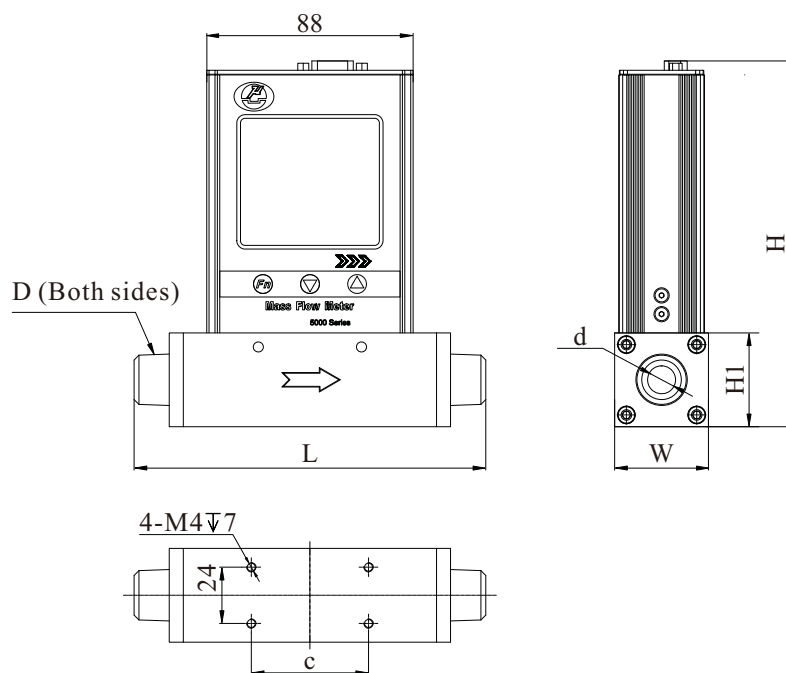

Model	DN (mm)	D (NPT-M)	L	H	H1	W	d	c
<b>MF5003</b>	3.0	1/8"	118	144	28	38	Φ3	36
<b>MF5006</b>	6.0	1/4"	124	144	28	38	Φ6	36
<b>MF5008</b>	8.0	3/8"	124	151	35	38	Φ8	50
<b>MF5012</b>	12.0	1/2"	150	156	40	40	Φ12	50
<b>MF5019</b>	19.0	3/4"	182.5	156	40	40	Φ19	70

## 5.2 Installation Instructions

The product at the time of shipment is fully inspected for product quality and meets all safety requirements. Additional safety measures during the installation should be applied. This includes, but is not limited to leakage verification procedures, standard EDS (electrostatic discharge) precautions, DC voltage precautions, and heavy duty precautions. Other tasks such as calibration, part replacement, repair, and maintenance must only be performed by trained personnel. Upon requests, manufacturer will provide necessary technical support and/or training of the personnel.

Do not open the product cover or alter any part of the product. Any such actions will forfeit the terms of the warranty and cause the liability to any damages thereafter.

The product is preferably to be installed horizontally. Flow direction should be aligned with the arrow mark on the meter body. If the flow fluid may have particles or debris, a filter is strongly recommended to be installed upstream of the meter.

Please follow the following steps to complete the installation:

- a) Upon opening the package, the product physical integrity should be inspected to ensure no visual damage.
- b) Before installation of the product, please ensure that the pipe debris or particles or any other foreign materials are completely removed.
- c) Cautions during installation:
  - (i) It is preferably to first install the inlet end of the meter and then the outlet end of the meter; To ensure the measurement accuracy, an upstream straight pipe of length no less than 10DN and a downstream straight pipe of length no less than 5DN should be in place.

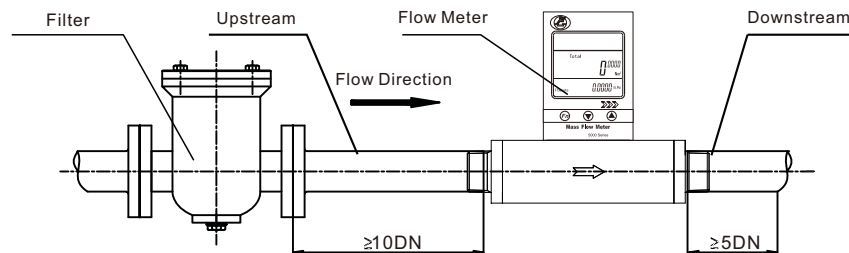

- (ii) If there is requirement of different pipe size at either upstream or downstream, the size of the pipe diameters should be larger than that of the selected meters. Please see detailed as below:

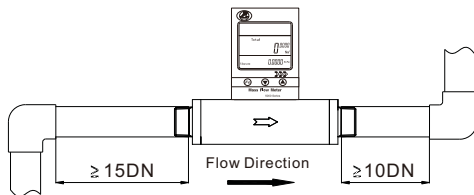

( a ) 90 degree elbow or T-piece

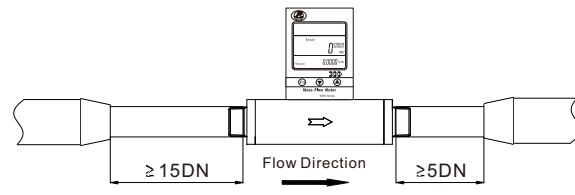

( b ) Reduction

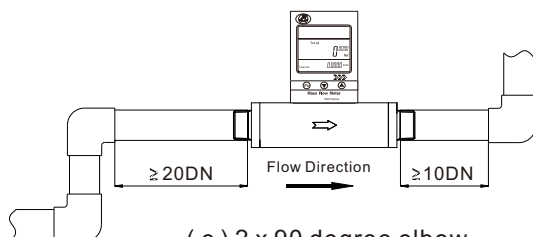

( c ) 2 x 90 degree elbow

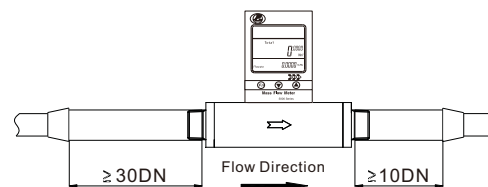

( d ) Expansion

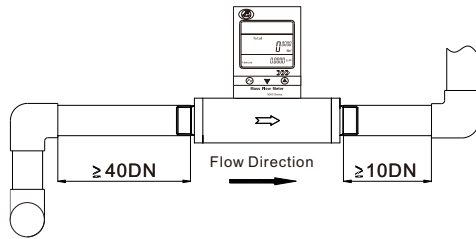

( e ) 2 x 90 degree elbow, 3-dimensional

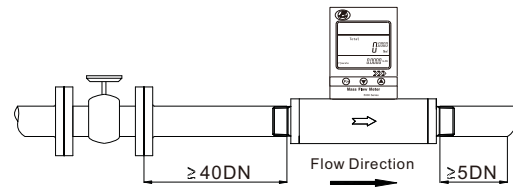

( f ) Control valve

- (iii) During installation, please make sure no any foreign materials (such as water, oil, dirty, particles, etc.) falling into the pipe.
- d) Connect electrical wires for LCD, and then electrical wires for inputs/outputs. Please pay special attention to power supply range (i.e., +12~+24 VDC) and power supply polarization (see the description on Electrical Interfaces in this manual).
- e) When connect the communication wires, please make sure that the wires are correctly connected to the proper ports on your data device/equipment.
- f) Turn on the power supply, and make sure that the LCD works correctly.
- g) Slowly open the valves at the both ends of the pipeline, and the meter should then start to measure the flow in the pipeline
- h) Completion of the installation.

### 5.3 Cautions

- a) Welding the pipe while the meter is installed is prohibited;
- b) Any foreign materials in the pipeline after installation may cause irreversible damage;
- c) Seal gaskets must not block flow channel otherwise accuracy cannot be maintained;
- d) The meter should be properly grounded via the electrical connection;
- e) After installation, severe force applied to the meter may cause damage;
- f) Severe vibration or very strong magnetic field may cause malfunction.



## 6. Operation and Communication

### 6.1 Cable Definition

The electrical interfaces are defined as Figure 6-1:

Pin	Definition	Color
1	4~20mA output	Purple
2	RS485(B)	Brown
3	4~20mA GND	Colorless
4	Pulse output	Yellow
5	Pulse GND	White
6	N.C.	Blue
7	RS485 (A)	Green
8	Ground (Common)	Black
9	Power supply (+)	Red

### User Interface DB-9 (Male)

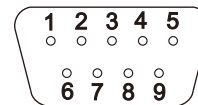

Figure 6-1. User Interface

### 6.2 LCD Display

Normally, the LCD display looks as Figure 6-2:

A standard litre (SL) represents a litre of the measured gas at 20°C and 101.325 kPa.

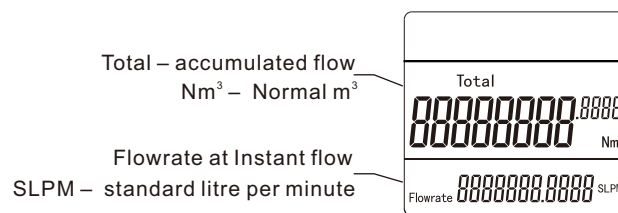

Figure 6-2. Normal Display

Alarm code E1~E5 (Figure 6-3) :

E1	Sensor error	E4	EEPROM error
E2	ADC error	E5	Crystal error
E3	RTC error		

### 6.3 RS485 Communication

For purposes of computer control and networking, the RS485 is used for communication with the following settings:

Baud rate (Bits per second):	57600(P0, Single-device communication)
	9600(P1 & P2, Multi-device communications)
Date bits:	8;
Parity:	None;
Stop bits:	1;
Flow control:	None.

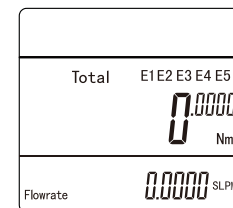

Figure 6-3. Error alarm display

### 6.4 4~20mA Output

For customers who use 4~20mA output. The connection of the loop load resistor is illustrated as Figure 6-4:  $R_L$  (max) = 850Ω (24Vdc power supply)

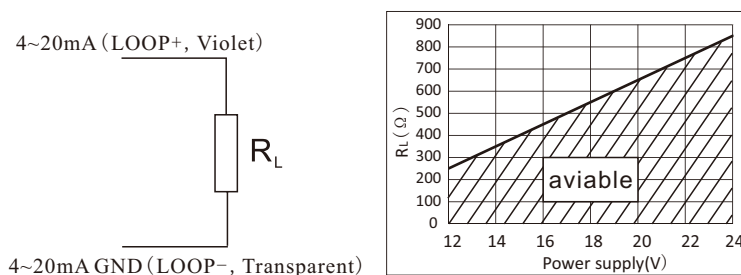

Figure 6-4. 4~20mA External Connection

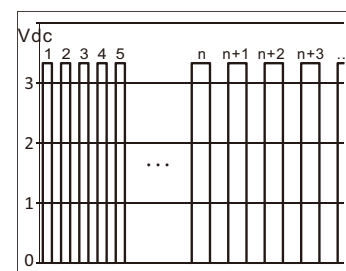

Figure 6-5. Even square wave of accumulated flow

### 6.5 Pulse Output

The pulse output is in the form of even square wave that is composed of 3.3V signal high and 0V signal low (Figure 6-5), and each pulse can be programmed to 0.001Nm<sup>3</sup>, 0.01Nm<sup>3</sup>, 0.1Nm<sup>3</sup> or 1Nm<sup>3</sup>, respectively. (default is 1Nm<sup>3</sup>).

## 6.6 Setup via Buttons

### 6.6.1 Button definition

Three buttons:   

 : Selection/confirmation of a setting

 : Scroll up the setup menu

 : Scroll down the setup menu

### 6.6.2 Operation

(1) The user interface (Figure 6-6):

Button  is used for function selection. After press it, the menu asks for password (authentication mode).

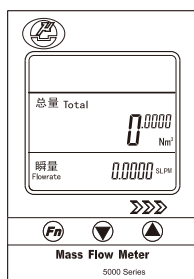

Figure 6-6 User Interface

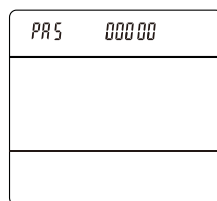

Figure 6-7 Password menu

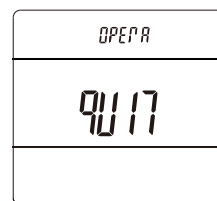





Figure 6-8 Function setup menu

(2) Password interface (Figure 6-7):

In the password menu, the flow measurement will not be interrupted, whereas the first line of the LCD display will show the password menu as Figure 6-8:

- The password consists of six numeric digits. The blinking digit can be assigned a numeric value, which can be selected from 0-9 through the up/down buttons  .
- After selecting a desirable value, press  to conform the selection, and the proceed to the next digit.
- After the password is correctly set, the meter enters the function setup menu. Otherwise, the meter returns back to the user mode. **(NOTE: The default password is 11111)**

(3) Function setup menu (Figure 6-7):





**▲ Caution: If you want change any settings, please refer to the manual, otherwise the meter maybe work abnormally.**

A 

“qUIT”, exit from the setup mode (this is the default option).

B 

“UnITACC”, select *accumulated flow units*.

- Press , the display will show the accumulated flow units menu; if the value is “--n3--”, the accumulated flow unit is Nm<sup>3</sup>; if the value is “--SL--”, the accumulated flow unit is SL.
- Press   to switch in two units.
- After selection, press  to confirm and exit.

- C **UnITTyPE** “UnITTyPE”, select *instant flow units*.
- Press **Fn**, the display will show the instant flow units menu; if the value is “--n3--”, the instant flow unit is Nm<sup>3</sup>/h; if the value is “--SL--”, the instant flow unit is SLPM.
  - Press **▼▲** to switch in two units.
  - After selection, press **Fn** to confirm and exit.
- D **InTErVAL** “InTErVAL”, set response time.
- Press **Fn**, the display will show the response time (default value is 125 ms).
  - Press **▼▲** to set as other response time, 250 ms, 500 ms, 1000 ms (1 s), 2000 ms (2 s), 4000 (4 s).
  - After selection, press **Fn** to confirm and exit.
- E **SEt GCF** “SET GCF”, Set the gas correction factor. See detailed operation in Figure 6-11.
- F **PrOTOCOL** “PrOTOCOL”, select communication protocols. .
- Press **Fn**, the display will show the protocol menu; P0-000 means mode 0, it is Single-device communication mode; P1-xxx (between 001 and 255) means mode 1, Modbus mode, it is Multi-device communication mode. P2-xxx (between 001 and 255) means mode 2, reserved, it is Multi-device communication mode. (e.g, P1-153 means the meter is working in Multi-device communication mode, protocol is Modbus, and the address is 153.)
  - Press **▼▲** to switch in two communication modes.
  - After selection, press **Fn** to confirm and exit.
- G **SEt Addr** “SET Addr”, Set the address for *Multi-device communication mode*.
- Notes: The default address is 255.**
- H **SEt PAS** “SET PAS”, Set the password.
- Notes: Please remember the new password and placed it properly.**
- I **OFFSEt** “OFFSET”, reset the offset of the meter. See detailed operation in Figure 6-11.
- J **CLear<sup>ACC</sup>** “CLEAR ACC”, reset the flow accumulation reading to zero.
- See detailed operation in Figure 6-11.

#### (4) Communication Modes switches (Figure 6-9, Figure 6-10)

- A. From *Single-device communication* to *Multi-device communication*
- Set the address of the meter (value of **SEt Addr**) as (3).E. such as 255;
  - Set the meter to *Multi-device communication mode* (select value of **PrOTOCOL** to P1-255 or P2-255) as (3).D;
  - After setting, the address will show on the LCD.
- B. From *Multi-device communication* to *Single-device communication*
- Set the meter to *Signal-device communication mode* (select value of **PrOTOCOL** to P0-000) as (3).D;
  - After setting, no address will show on the LCD.

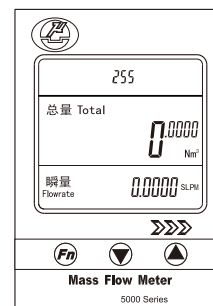

Figure 6-9 Multi-device communication mode

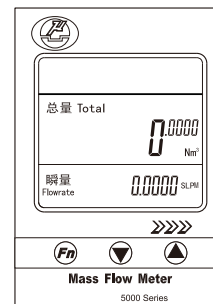

Figure 6-10 Single-device communication mode

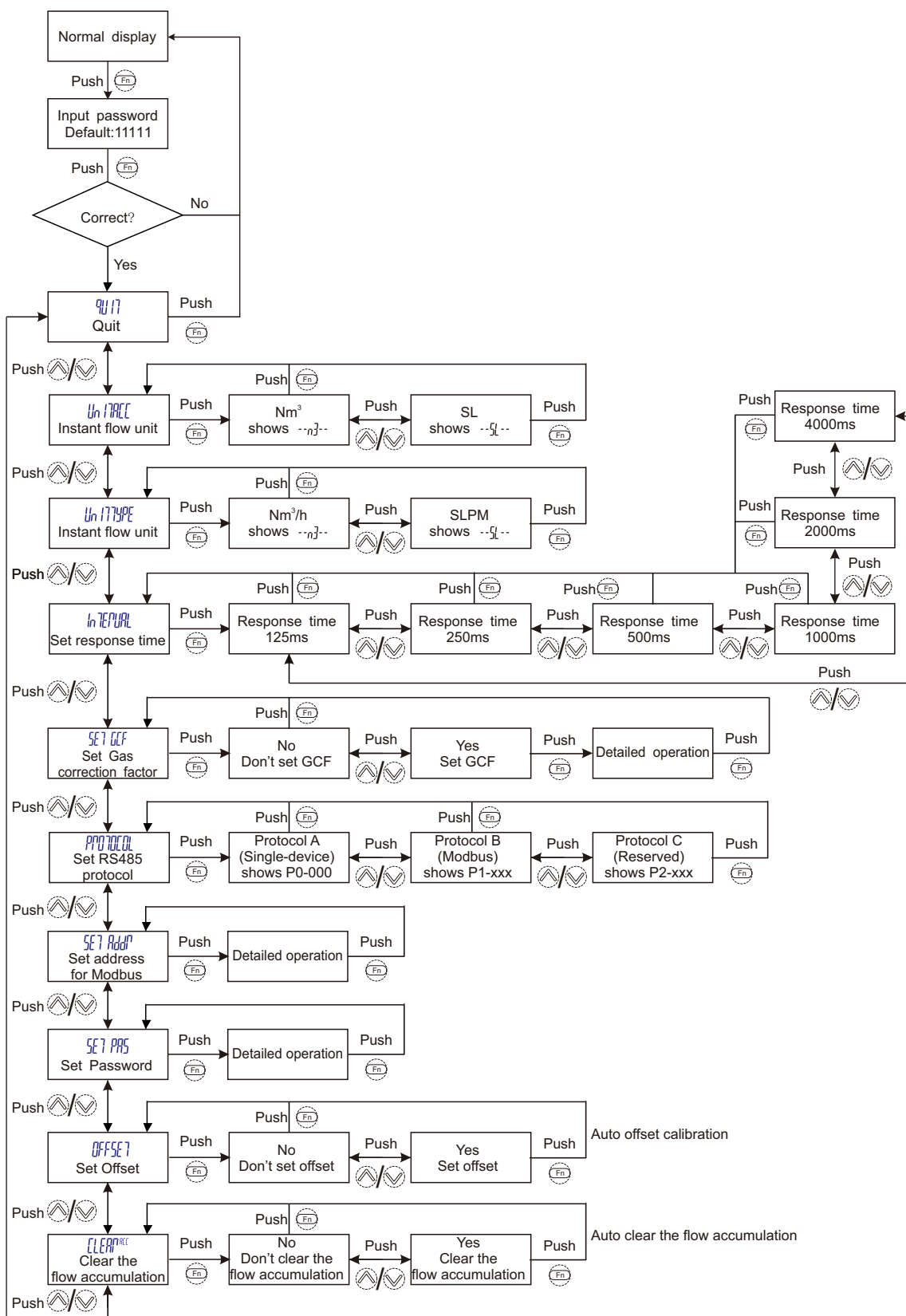

Figure 6-11 Button operation

## 7.Safety and Maintenance

### 7.1 Wetted Materials and Compatibility

The meter body and pipe are made of 304 stainless steel. Sensors comprise of silicon, silicon nitride and silicon dioxide and the sensor surfaces are passivated with silicon nitride and silicon dioxide. The electronic sealing is provided by RTV (room temperature vulcanizing) silicone sealant WR-704 composed of  $\text{HOCH}_3(\text{SiO})_n\text{CH}_3\text{H}$ .

### 7.2 Safety Precautions

The product is designed for use with general purpose gases such as air and nitrogen. It is advised that the products are best used for non-explosive clean gases. The sensors cannot be used for gas metrology of fluoride or fluoride containing gases. For updates of the product certification information, please contact manufacturer or visit [www.Siargo.com](http://www.Siargo.com). Use for other gases such as extreme corrosive and toxic may cause the product malfunctioning or even severe damages. The product sealing is ensured to work under working pressure of 1.0 MPa and is leakage proof before the shipment. But cautions and further leakage test are important at installation as well since any leakage could cause severe safety issue. The power supply for this product is 12~24 VDC, all precautions and measures for electrical voltage handling must apply.

**Attention: any alternation and/or improper use of the product without the permission of the manufacturer can cause unpredicted damages and even injuries or other severe situations. Siargo Inc or any of its employees, subsidiaries shall not be hold and indemnified against such consequences due to such circumstances via improper use of the product.**

### 7.3 Maintenance

**Attention: without prior permission of the manufacturer, please do not attempt to alter any parts of the product as it may cause unrecoverable damages. If there are questions or doubts, please contact manufacturer immediately before further actions. Please ensure the DC power is off before disassembling the sensor.**

All maintenance of the sensor should be done by trained and certified personnel by Siargo Ltd.

## 8. Warranty

Siargo warrants the products sold hereunder, properly used and properly installed under normal circumstances and service as described in the user's manual, shall be free from faulty materials or workmanship for 180 days for OEM products, and 365 days for non-OEM products from the date of shipment. This warranty period is inclusive of any statutory warranty. Any repair or replacement serviced product shall bear the same terms in this warranty.

Siargo makes no other warranty, expressed or implied and assumes no liability for any special or incidental damage or charges, including but not limited to any damages or charges due to installation, dismantling, reinstallation or any other consequential or indirect damages of any kind. To the extent permitted by Law, the exclusive remedy of the user or purchaser, and the limit of Siargo's liability for any and all losses, injuries or damages concerning the products including claims based on contract, negligence, tort, strictly liability or otherwise shall be the return of products to Siargo, and upon verification by Siargo to prove to be defective, at its sole option, to refund, repair or replacement of the products. No Action, regardless of form, may be brought against Siargo more than 365 days after a cause of action has accrued. The products returned under warranty to Siargo shall be at user or purchaser's risk of loss, and will be returned, if at all, at Siargo's risk of loss. Purchasers or users are deemed to have accepted this limitation of warranty and liability, which contains the complete and exclusive limited warranty of Siargo, and it shall not be amended, modified or its terms waived except by Siargo's sole action.

This warranty is subject to the following exclusions:

- a). Products that have been altered, modified or have been subject to unusual physical or electrical circumstances indicated but not limited to those stated in the user's manual or any other actions which cannot be deemed as proper use of the products
- b). Siargo does not provide any warranty on finished goods manufactured by others. Only the original manufacturer's warranty applies.